

Linear Luminaire for Fluorescent Lamps

Series EXLUX 6401



www.stahl.de



15454E00

- > As wall, ceiling and pendant light fitting or pole mounted light fitting
- > Version with 2 lamps: 18 W, 36 W and 58 W
- > Central locking
- > All-pole disconnection by means of an N/C switch when the lamp is opened (optional)



E2

The luminaires of the series **EXLUX 6401** can be used for general lighting as well as emergency lighting which is supplied with current via a group or central system.

Zone	ATEX / IECEx					
	0	1	2	20	21	22
For use in:			x		x	x

Explosion Protection

Global (IECEx)	
Gas and dust	IECEx PTB 14.0035 Ex nA IIC T4 Gc Ex nA d IIC T4 Gc Ex tb IIIC T80 °C Db Ex tc IIIC T80 °C Dc
Europe (ATEX)	
Dust	PTB 14 ATEX 2016 ⊕ II 2 D Ex tb IIIC T80° C Db
Gas and dust	PTB 14 ATEX 2017 ⊕ II 3 G Ex nA IIC T4 Gc ⊕ II 3 G Ex nA d IIC T4 Gc ⊕ II 3 D Ex tc IIIC T80 °C Dc
Certifications and certificates	
Certificates	IECEx, ATEX

WebCode 6401A

Linear Luminaire for Fluorescent Lamps

Series EXLUX 6401

Selection Table

Version	Length mm	Lamps	Spring clamp terminal up to 4 mm ²	Screw-type terminal	Cable glands	Art. no.	Order number	Weight kg	
EXLUX 6401	700	2x 18 W	x		Plastic M25	239552	6401/522-8508-15-131	3.200	
					Metal M20	239555	6401/522-8508-15-232	3.200	
				x		Plastic M25	239558	6401/522-8508-25-131	3.200
						Metal M20	239561	6401/522-8508-25-232	3.200
	1310	2x 36 W	x		Plastic M25	239553	6401/542-8508-15-131	5.500	
					Metal M20	239556	6401/542-8508-15-232	5.500	
				x		Plastic M25	239559	6401/542-8508-25-131	5.500
						Metal M20	239562	6401/542-8508-25-232	5.500
	1610	2x 58 W	x		Plastic M25	239554	6401/562-8508-15-131	7.900	
					Metal M20	239557	6401/562-8508-15-232	7.900	
				x		Plastic M25	239560	6401/562-8508-25-131	7.900
						Metal M20	239563	6401/562-8508-25-232	7.900
Order Number Supplement									
Through wiring	without					6401/5...0.....			
	with 5 conductors					6401/5...5.....			
ECG	220 ... 240 V 2-lamps AC, 1-lamp DC					6401/5...0.....			
	220 ... 240 V 2-lamps AC, 2-lamps DC					6401/5...1.....			
	110 ... 240 V 2-lamps AC, 1-lamp DC (only 18 W and 36 W)					6401/5...2.....			
	110 ... 240 V 2-lamps AC, 2-lamps DC (only 18 W and 36 W)					6401/5...3.....			
	220 ... 240 V 2-lamps AC, 2-lamps DC (standard)					6401/5...8.....			
Connection terminal	Spring clamp terminal type WAGO 0.5 ... 4 mm ²					6401/5...-1....			
	Screw-type terminal type STAHL 1.5 ... 6 mm ²					6401/5...-2....			
Cable glands	Plastic	3 x M25 entries 2 x M25 x 1.5 cable glands and 2 x M25 x 1.5 stopping plugs (enclosed)			6401/5...-131				
	Plastic	4 x M25 entries 2 x M25 x 1.5 cable glands and 2 x M25 x 1.5 stopping plugs (enclosed)			6401/5...-141				
	Metal	3 x M25 entries Cable gland and stopping plug Please order as accessories			6401/5...-132				
	Metal	4 x M25 entries Cable gland and stopping plug Please order as accessories			6401/5...-142				
	Metal	3 x M20 entries Cable gland and stopping plug Please order as accessories			6401/5...-232				
	Metal	4 x M20 entries Cable gland and stopping plug Please order as accessories			6401/5...-242				
Note	The lights are delivered without fluorescent lamps and assembly parts. These parts must be ordered separately!								

Linear Luminaire for Fluorescent Lamps

Series EXLUX 6401



Technical Data

Electrical data

Ballast	6401/...-...0-...-...		6401/...-...1-...-...			
	Lamp start	Cold start		Cold start		
Voltage	220 ... 240 V AC		220 ... 240 V AC			
DC voltage in case of ignition	198 ... 264 V DC		198 ... 264 V DC			
DC voltage during operation	176 ... 264 V DC		198 ... 264 V DC			
Frequency	0 / 50 ... 60 Hz		0 / 50 ... 60 Hz			
Lamp operation DC	1-lamp		2-lamp			
Lamp standard	IEC 60081		IEC 60081			
Lamp power	18, 36, 58 W		18, 36, 58 W			
Nominal current	1 x 18 W, 85 mA 2 x 18 W, 170 mA 1 x 36 W, 160 mA 2 x 36 W, 320 mA 1 x 58 W, 250 mA 2 x 58 W, 500 mA		1 x 18 W, 85 mA 2 x 18 W, 170 mA 1 x 36 W, 160 mA 2 x 36 W, 320 mA 1 x 58 W, 250 mA 2 x 58 W, 500 mA			
	6401/...-...2-...-...		6401/...-...3-...-...		6401/...-...8-...-...	
Lamp start	Cold start		Cold start		Cold start	
Voltage	110 ... 240 V AC		110 ... 240 V AC		220 ... 240 V AC	
DC voltage in case of ignition	104 ... 264 V DC		104 ... 264 V DC		198 ... 264 V DC	
DC voltage during operation	104 ... 264 V DC		104 ... 264 V DC		176 ... 264 V DC	
Frequency	0 / 50 ... 60 Hz		0 / 50 ... 60 Hz		0 / 50 ... 60 Hz	
Lamp operation DC	1-lamp		2-lamp		2-lamp	
Lamp standard	IEC 60081		IEC 60081		IEC 60081	
Lamp power	18, 36 W		18, 36 W		18, 36, 58 W	
Nominal current	1 x 18 W, 85 ... 175 mA 2 x 18 W, 170 ... 345 mA 1 x 36 W, 155 ... 330 mA 2 x 36 W, 310 ... 660 mA		1 x 18 W, 85 ... 175 mA 2 x 18 W, 170 ... 345 mA 1 x 36 W, 155 ... 330 mA 2 x 36 W, 310 ... 660 mA		1x18W 80mA 2x18W 150mA 1x36W 160mA 2x36W 300mA 1x58W 250mA 2x58W 480mA	
Power factor $\cos \varphi$	$\cos \varphi \geq 0.97$ capacitive; no additional compensation required					
Disconnection of the light	When opening the luminaire Switch with safety lock (optional); when opening the central lock all poles of the voltage supply to the ballast are disconnected; contacts of the switching element are positive opening, they can only be switched on again when the translucent cover and the central locking system are closed.					
End of life switch	in case of a lamp failure, the electronic ballast disconnects the defective lamp from the power supply. If the 2-channel EB is used the channel of the defective lamp is switched off, but the channel using the intact lamp remains operational.					
Luminous characteristics						
Lamps	18 W	60081-IEC-2220	G13			
	36 W	60081-IEC-2420	G13			
	58 W	60081-IEC-2520	G13			
	Please use cold start lamps.					

E2

Linear Luminaire for Fluorescent Lamps

Series EXLUX 6401

Technical Data

Ambient conditions

Operating temperature range

Type	Through wiring	
	without	with
6401/52.-...0-.-.-...	-30 °C ... 60 °C	-30 °C ... 50 °C
6401/52.-...1-.-.-...	-30 °C ... 60 °C	-30 °C ... 50 °C
6401/52.-...2-.-.-...	-30 °C ... 45 °C	-30 °C ... 40 °C
6401/52.-...3-.-.-...	-30 °C ... 45 °C	-30 °C ... 40 °C
6401/52.-...8-.-.-...	-30 °C ... 60 °C	-30 °C ... 50 °C
6401/54.-...0-.-.-...	-30 °C ... 55 °C	-30 °C ... 50 °C
6401/54.-...1-.-.-...	-30 °C ... 55 °C	-30 °C ... 50 °C
6401/54.-...2-.-.-...	-30 °C ... 45 °C	-30 °C ... 40 °C
6401/54.-...3-.-.-...	-30 °C ... 45 °C	-30 °C ... 40 °C
6401/54.-...8-.-.-...	-30 °C ... 55 °C	-30 °C ... 50 °C
6401/56.-...-.-.-...	-20 °C ... 55 °C	-20 °C ... 50 °C

The lowest ambient temperature when used with breather is -20 °C.

Mechanical data

Degree of protection

IP66 (IEC 60598)
IP66 / IP67 (IEC 60598) 18 W and 36 W

Protection class

I (with internal PE connection)

Impact strength (IK code)

IK10 (IEC 62262)

Material

Enclosure

Enclosure

Colour

Translucent cover

Gasket

Luminaire locking

Polyester resin, glass fibre-reinforced
colour grey, similar to RAL 7035

Polycarbonate

Silicone foam gasket in the lamp cover

Central locking which can be opened/closed using a socket key M8 / wrench size 13, hinged lamp cover

Mounting / Installation

Cable glands

Standard luminaire

Plastic: 2 x M25 x 1.5 cable gland 8161 and
2 x M25 x 1.5 stopping plugs 8290 (enclosed)

Metal: 2 x metal plates M20 x 1.5 connected by means of PE for metal cable entries
Attention: cable entries must be ordered separately

Special: max. 4 bores for M20, M25, NPSM ½"
max. 2 bores for NPT ¼"

Metal cable glands: M20 x 1.5, M25 x 1.5; earthing of the metal cable entries by means of metal plates

Connection

Standard: Spring clamp terminals
5-pole: L1, L2, L3, N, PE
Clamping range: 1 x 0.75 ... 4 mm² (solid / finely stranded)
4 mm² finely stranded without core end sleeve only
(2 free clamping units for each pole available)

Special: Terminal block with covering
5-pole: L1, L2, L3, N, PE
Clamping range: 2 x 1.5 ... 6 mm² (solid); 2 x 1.5 ... 4 mm² (finely and extra finely stranded)

Through wiring

Through wiring **Standard luminaire**
Luminaires are equipped with internal through wiring.
Ingoing and outgoing leads can be connected on the opposite sides.
Terminals: see Techn. data
Wiring cross-section: 2.5 mm² for max. 16 A

without **Optional**
On the connection side, there are 2 bores M25 x 1.5 for cable entries for ingoing and outgoing wiring of the connection line (ingoing and outgoing leads on one side).

Assembly

For outdoor mounting, a breather is recommended

Standard luminaire

Standard: 2 x M8 insert nuts in the enclosure

Special: Mounting grooves in the enclosure for the use of fastening and ceiling rails for variable luminaire mounting
(variable mounting distances for luminaires 18 W: 320 ... 480 mm;
36 W / 58 W: 670 ... 930 mm)

Linear Luminaire for Fluorescent Lamps

Series EXLUX 6401



Light distribution curves

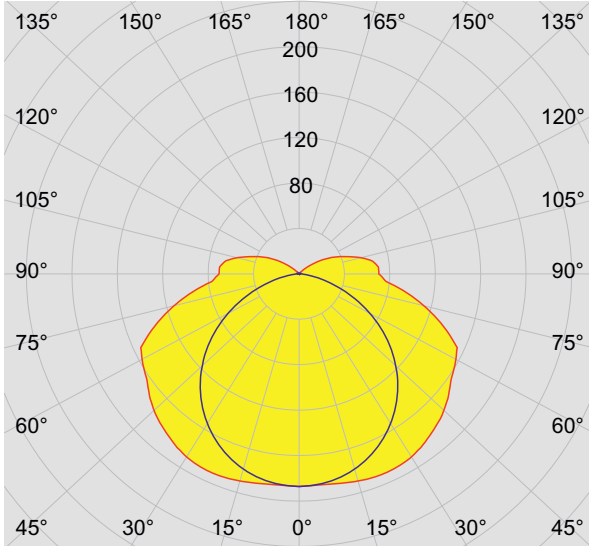

cd/klm
 — C0 - C180 — C90 - C270

83%

16697E00

2x 18 W

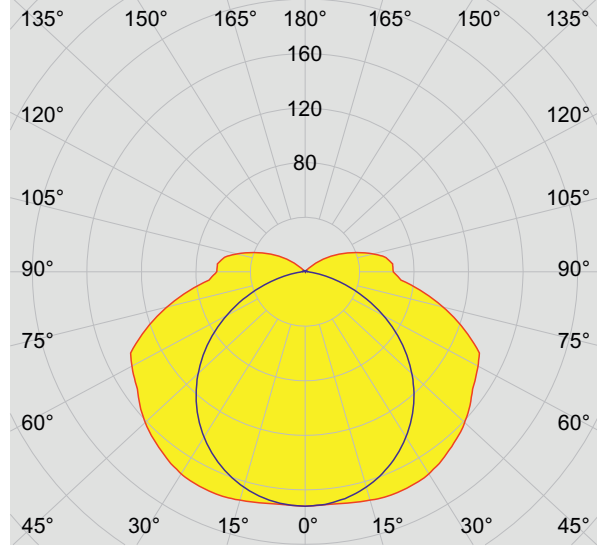

cd/klm
 — C0 - C180 — C90 - C270

77%

16698E00

2x 36 W

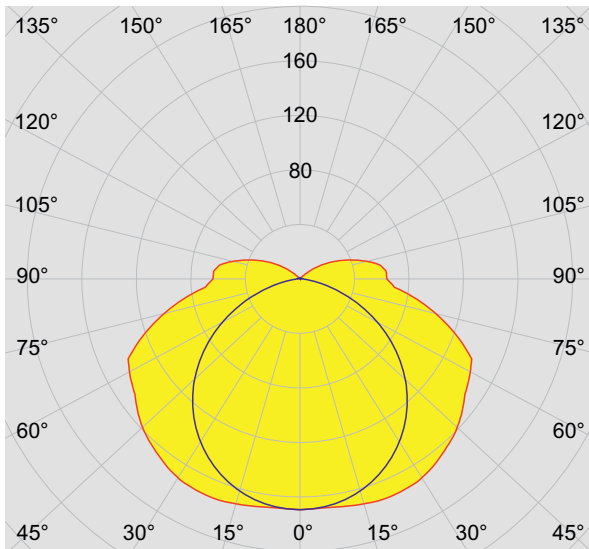

cd/klm
 — C0 - C180 — C90 - C270

75%

16699E00

2x 58 W

E2

Linear Luminaire for Fluorescent Lamps

Series EXLUX 6401

Accessories and Spare Parts

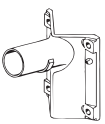
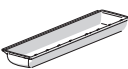
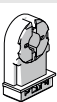
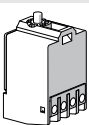
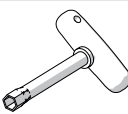
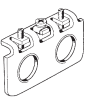
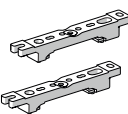



Designation	Figure	Description	Art. no.	Weight kg	
Fluorescent lamps	 04936E00	18 W 1350 lm	108952	0.100	
		36 W 3350 lm	108951	0.200	
		58 W 5200 lm	108950	0.220	
		Two-pin cap \varnothing 26 mm Light colour: universal white Pins made of brass			
Bracket for wall mounting with tube	 05460E00	for side entry lamp; with tube, length 400 mm, \varnothing 42 mm	108947	2.480	
Lamp cover		for luminaire L=700	222427	0.639	
		for luminaire L=1310	222428	1.149	
		for luminaire L=1610	222429	1.450	
		for luminaire L=700 (resistant to aromatic substances)	256534	0.639	
		for luminaire L=1310 (resistant to aromatic substances)	256535	1.149	
		for luminaire L=1610 (resistant to aromatic substances)	256536	1.450	
Lamp-holder	 05888E00	Lamp holder for two-pin cap lamps G 13	107275	0.008	
Switch	 10809E00	Switching element 8080/1-3-L, 2 normally closed contacts	132527	0.025	
Socket key	 15507E00	M8 / wrench size 13; to open/close the central locking	222430	0.210	
Adapter plates	 05755E00	1 x M20 x 1.5	1 piece	115815	0.070
		1 x M25 x 1.5	1 piece	115818	0.070
		1 x NPSM 1/2"	1 piece	115821	0.070
		1 x NPT 3/4"	1 piece	115824	0.070
		2 x M20 x 1.5	1 piece	115826	0.060
		2 x M25 x 1.5	1 piece	115828	0.060
		2 x NPSM 1/2"	1 piece	115829	0.060
		for use together with metal cable glands; the metal cable glands are integrated in the earthing system via adapter plates			
Mounting rail	 15584E00	for a variable mounting distance	1 pair	222826	0.300

Linear Luminaire for Fluorescent Lamps

Series EXLUX 6401

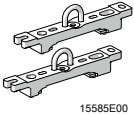

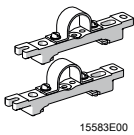
Accessories and Spare Parts

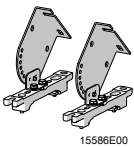
Designation	Figure	Description	Art. no.	Weight kg
Mounting bracket	 15585E00	mounting clamp mounted on a mounting rail for a variable mounting distance	1 pair 222456	0.400
Pole mounting sleeve	 16985E00	for the subsequent mounting on lights 18 W and 36 W, completely with assembly parts	227512	3.300
Pipe clamp	 15583E00	R 1 1/2"	222459	1.200
		R 1 1/4"	222458	1.250
		R 2"	222460	1.300
		with mounting rail for a variable mounting distance; Material: stainless steel	1 pair	
Ring bolt	 05378E00	M8, direct mounting in insert nuts	1 pair 115736	0.120
Breathing gland	 05703E00	M25 x 1.5 in order to avoid condensate formation	115738	0.020
Ceiling and wall-mounting bracket	 15586E00	mounted on a mounting rail for a variable mounting distance; Material: stainless steel Lamp can be swiveled in steps of 15°	1 pair 222827	2.400

E2

Dimensional Drawings (All Dimensions in mm [inch]) - Subject to Modifications

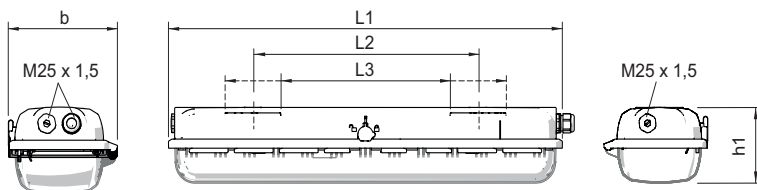

15440E00

Dimensions	Luminaire 17/18 W	32/36 W	40/58 W
L1	700 [27.56]	1310 [51.57]	1610 [63.39]
L2 ¹⁾	400 [15.75]	800 [31.50]	800 [31.50]
L3 ²⁾	320 ... 480 [12.60 ... 18.90]	670 ... 930 [26.38 ... 36.61]	670 ... 930 [26.38 ... 36.61]
b	184 [7.24]	184 [7.24]	184 [7.24]
h1	125 [4.92]	125 [4.92]	125 [4.92]

¹⁾ fixed mounting distance
²⁾ variable mounting distance

EXLUX 6401 Standard luminaire

Linear Luminaire for Fluorescent Lamps

Series EXLUX 6401

Dimensional Drawings for Assembly Parts and Accessories (All Dimensions in mm [inches]) - Subject to Alterations

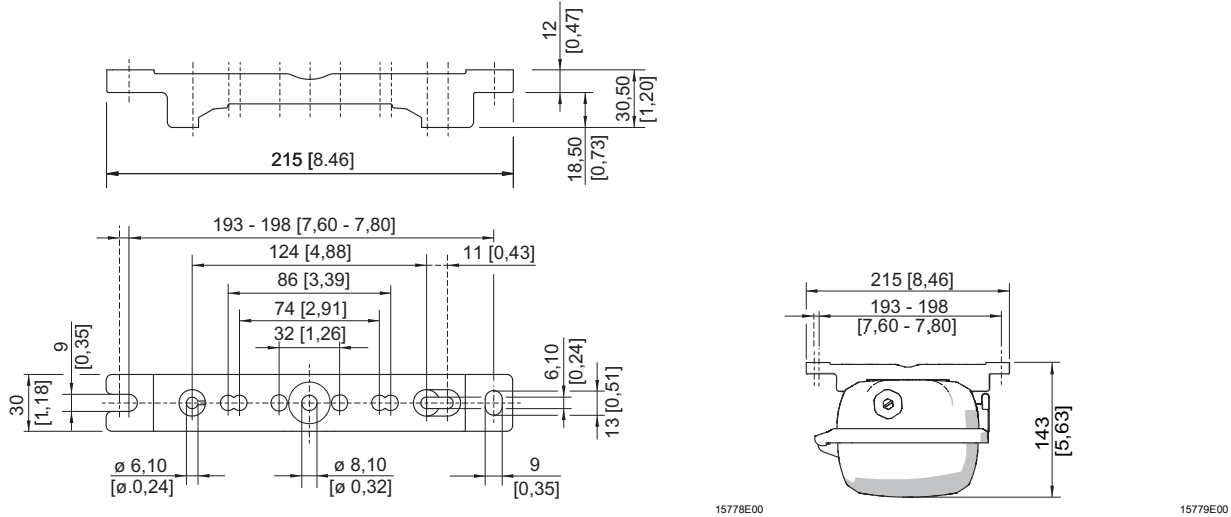

Mounting rail

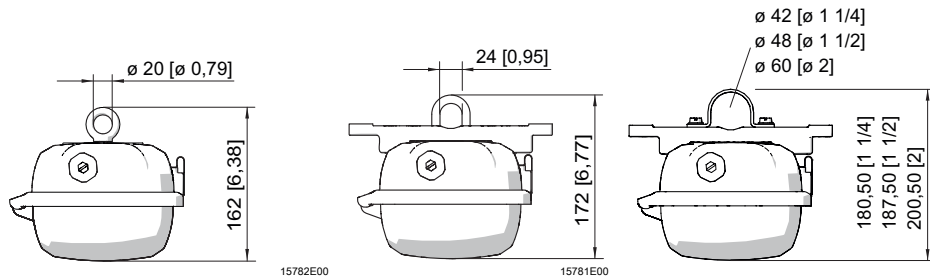

Ring bolt fitted in insert nut of the luminaire

Mounting bracket fitted in mounting rail

Pipe clamp fitted in mounting rail

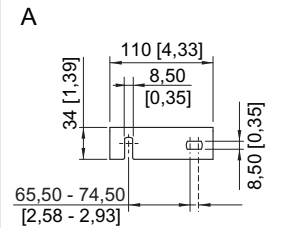
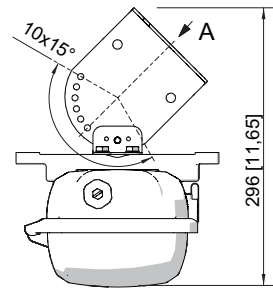

Wall mounting bracket fitted in mounting rail

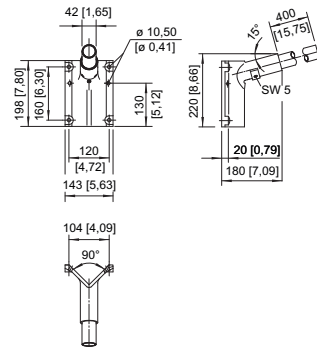

Bracket for wall mounting with pipe section

Linear Luminaire for Fluorescent Lamps

Series EXLUX 6401



Dimensional Drawings for Assembly Parts and Accessories (All Dimensions in mm [inches]) - Subject to Alterations

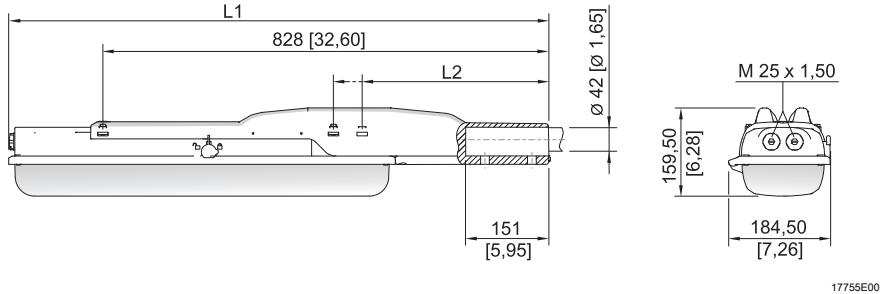

Dimension	Light	
	700 mm	1300 mm
L1	978 [38.50]	1587 [62.48]
L2	390 [15.35]	338 [13.31]

Linear Luminaire EXLUX with pole mounting sleeve

We reserve the right to make alterations to the technical data, weights, dimensions, designs and products available without notice. The illustrations cannot be considered binding.

E2