

Smoke Detection System *SDS-48*

For Cargo Holds Onboard Ships
acc. to FSS Code Chapter 10

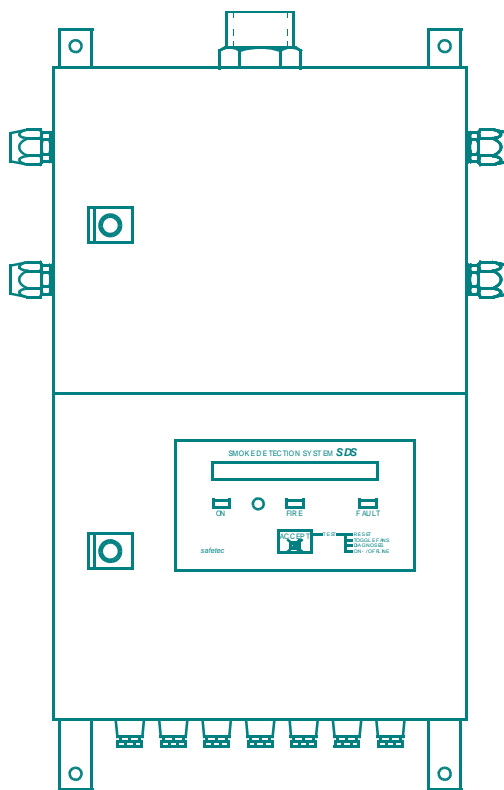

Product Catalogue

safetec Brandes und Niehoff GmbH
Arenskule 7-9
D-21339 Lüneburg
Germany
Tel.: ++49 - 4131 – 7670 - 200
Fax.: ++49 - 4131 – 7670 - 201
E-Mail: mail@safetec-online.com
Internet: www.safetec-online.com

Contents

Overviews

- Overview: Typical arrangement of Smoke Detection System SDS-48
- Overview: Components in Smoke Detection Panel SDS-4/8/12
- Overview: Components in Repeater Panel SDS-R48
- Overview: Components in Fan Unit SDS-M0440
- Overview: Pipe connecting parts at Smoke Detection Systems SDS-48

Tables

- Basic Parts
- Accessories
- Spare Parts

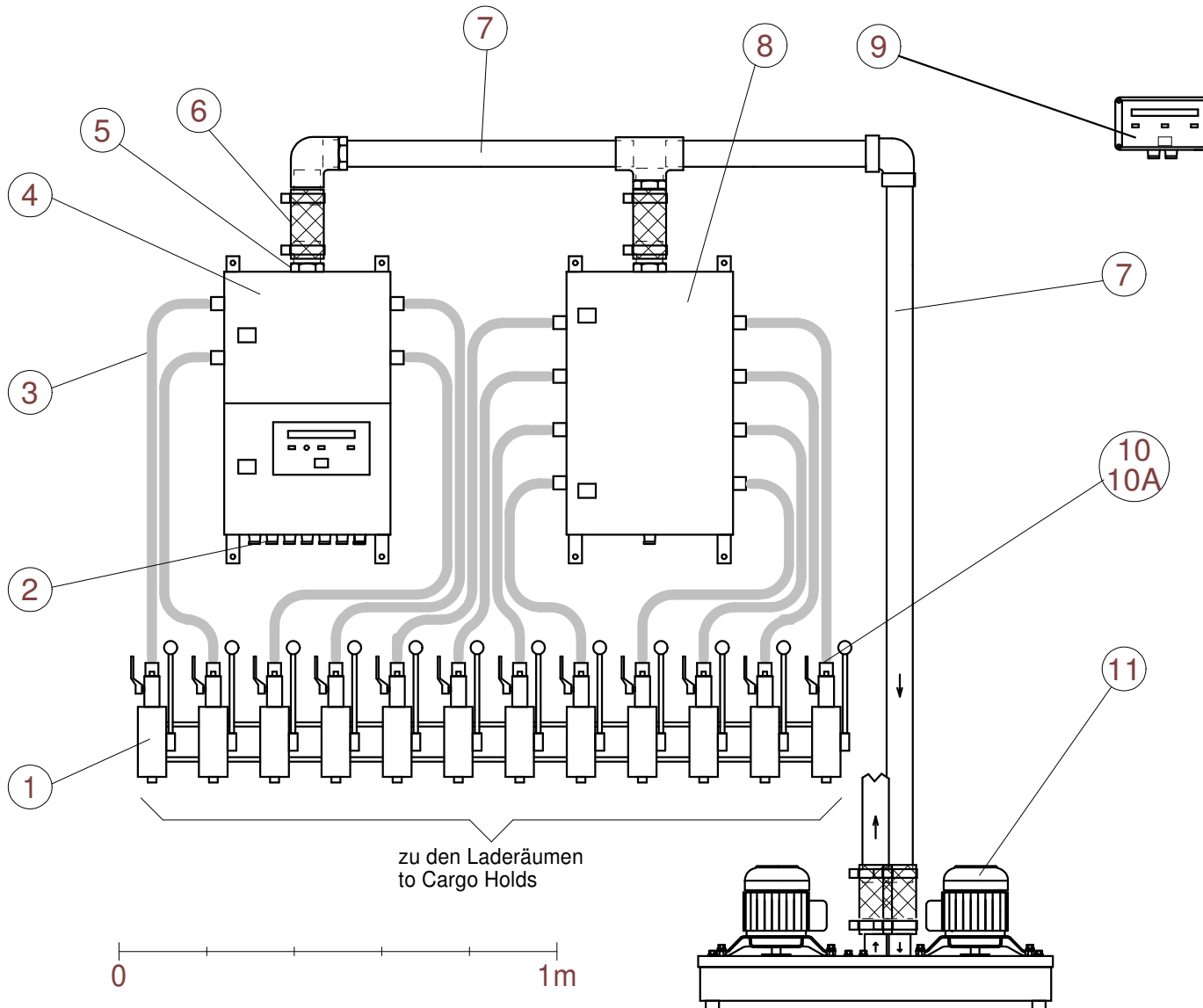

- 1 3-Wege-Ventil, Anschluss an CO2-Sammelrohr
not shown
3-Way-Valve, Connection to CO2-manifold not shown
 - 2 Kabelverschraubung
Cable Gland
 - 3 PVC-Schlauch 13/20 mm
PVC-Hose, 13/20mm
Art. Nr. Z02.002
 - 4 Rauchmeldezentrale SDS-4
Fire Alarm Panel
 - 5 Reduzierstück
Reduction
 - 6 Schlauchstück mit Schellen
Hose with Clamps
 - 7 Stahlrohr / Steelpipe
 - 8 Erweiterungsgerät SDS-E8
Extension Panel
 - 9 Fernanzeigegerät SDS-R48
Repeater Panel
 - 10 Schlauchverschraubung
Hose Connection Art.Nr. BG01.930
 - 10A Vorfilter
Prefilter Art.Nr. BG02.861
 - 11 Lüftereinheit SDS-M0440
Fan-Unit
- Pos. 5-7 Größe abhängig von der Anzahl der Meldelinien
size depends on total number of detection lines
(siehe Zeichnung BG02.03x / see drawing BG02.03x)

safetec

Beispiel: Rauchmeldeanlage SDS-48 mit 12 Kanälen
Typical Arrangement: Smoke Detection System SDS-48

Rev. 7	18.07.07	PE
Gepr.	18.07.07	kb
Bearb.	12.05.00	kb

Maßstab
1:15 SDS02.010.12.tcd

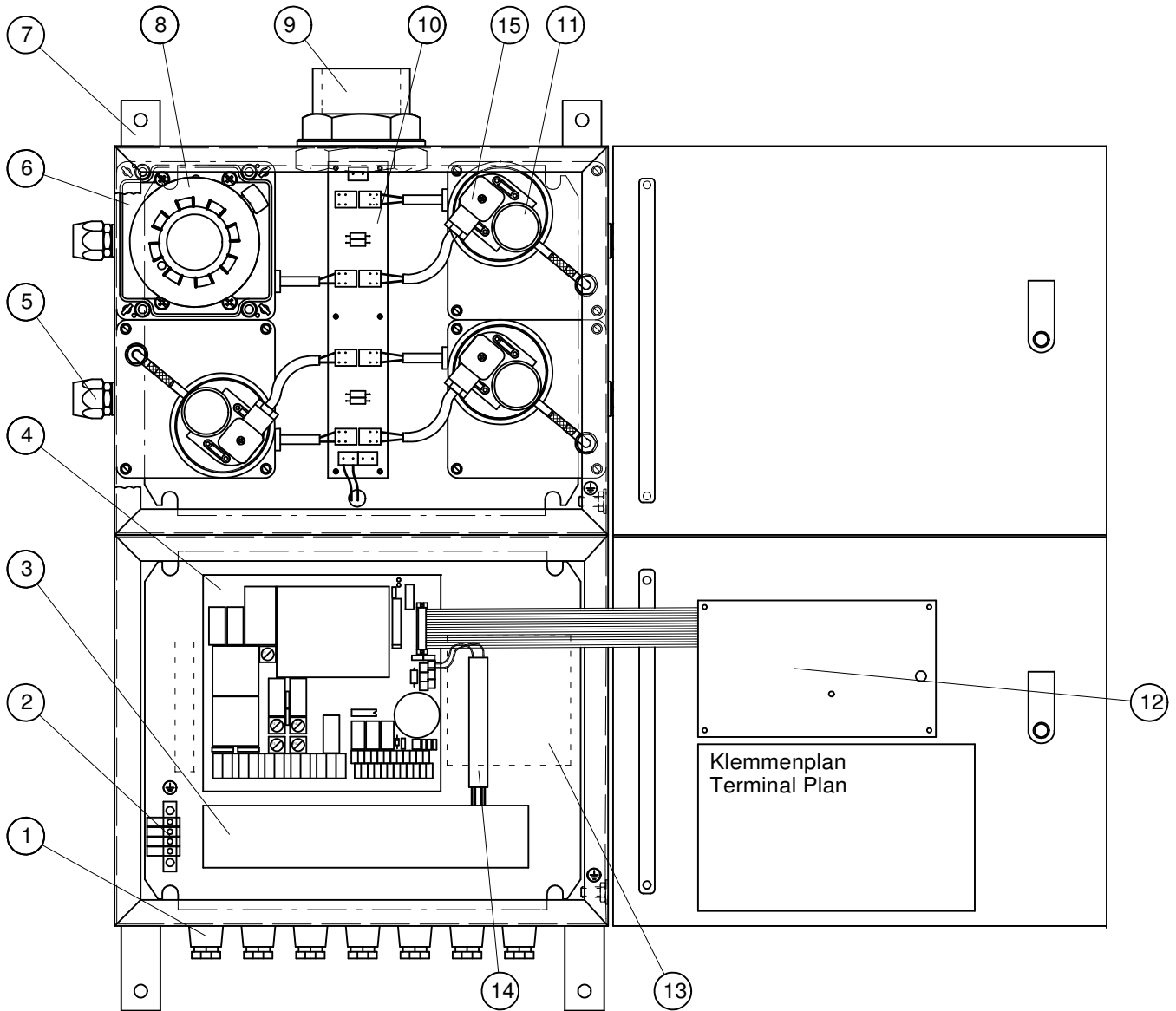

No.	Bezeichnung	Description	Art. No.
1	Kabelverschraubung	Cable Gland	
2	Anschluss Potentialausgleich	Earthbar	
3	Kabelkanal	Cable Duct	
4	Stromversorgungsmodul	Power Supply Module	BG02.600
5	Schlauchverschraubung Lufteintritt	Adapter Nipple for Detection Line	Z01.001
6	geöffnete Detektorbox	open Detector Box	
7	Befestigungswinkel	Mounting Strap	
8	Rauchmelder XP95 I.S.	Smoke Detector XP95 I.S.	E20.002
9	Anschlussnippel für Absaugung	Adapter Nipple for Fan Unit Connection	Z03.008
10a	Detektoranschlussmodul für max. 4 Kanäle	Detector Connection Module for max 4 Lines	BG02.810
10b	Detektoranschlussmodul für max. 8 Kanäle	Detector Connection Module for max 8 Lines	BG02.820
11	Druckschalter für Luftstromüberwachung	Pressure Switch for Airflow Monitoring	E01.003
12	Steuermodul	Control Module	BG02.500
13	Relaismodul (optional)	Relay Module (optional)	BG02.908
14a	1-Kanal-Trennwandler EEx i	Galvanic Isolator EEx i, 1 Channel	E06.101
14b	2-Kanal-Trennwandler EEx i	Galvanic Isolator EEx i, 2 Channels	E06.102
15	Stecker mit Leitung für E01.003	plug and cable for E01.003	BG02.090

Hinweis:

Wenn ein optionales Relaismodul eingesetzt wird, wird dieses rechts neben der Stromversorgungseinheit montiert. Der Trennwandler wird dann links von der Stromversorgungseinheit montiert (Positionen gestrichelt gezeichnet).

Remark:

If a optional relay module will be mounted, this will be placed right from the power supply module. The galvanic isolator will then be mounted left from the power supply module (positions are shown dotted).

Rev.	Date	By	Scale
Rev. 4	15.08.07	PeEi	Maßstab 1:5
Gepr.	15.08.07	KB	
Bearb.	26.04.00	HZ	

safetec

Teile in Rauchmeldezentrale SDS-4
Components in Smoke Detection Panel SDS-4

SDS02.021.tcd

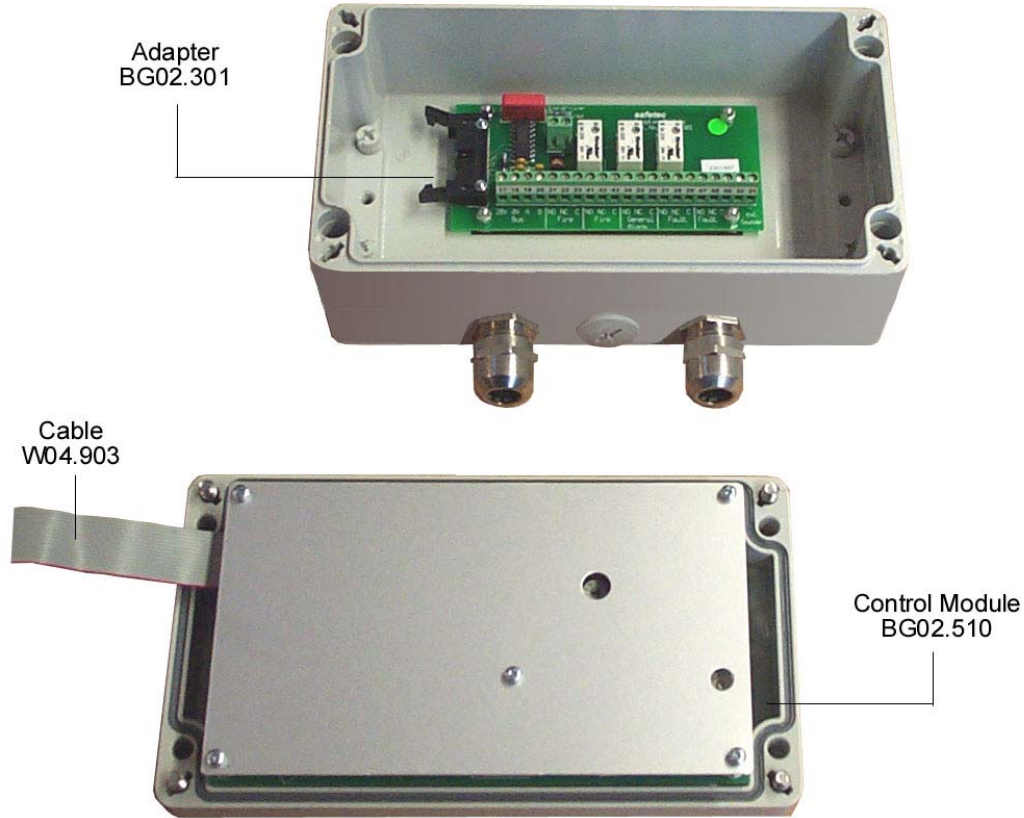

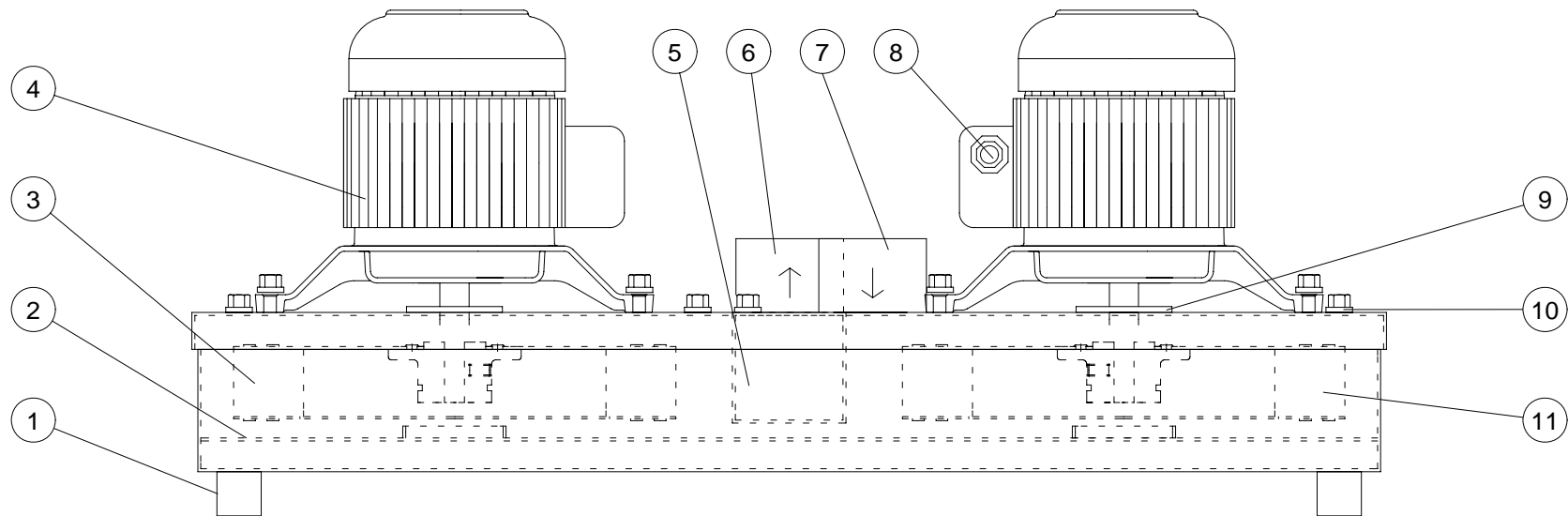

1 Schwingungsdämpfer
Shock Mount
2 Zwischenplatte
support plate
3 Gehäuse
Enclosure
4 Motor
Art.No. FAN02.121

5 Rückschlagklappe
Non Return Flap
6 Luftaustritt
Air Outlet
7 Lufteintritt
Air Inlet
8 Kabelverschraubung
Cable Gland

9 Wellendichtung
Shaft Sealing
Art.No. FAN02.035
10 Halterungsbolzen
Fastening Bolt
11 Lüfterrad
Impeller FAN02.017
12 Kabelverschraubung
Cable Gland

Pipe Connecting Parts at SDS-Devices

For proper airflow it will be vital to determine the correct air pipe size. Total number of detection lines and length of air pipe must be considered by planning staff. Safetec to be informed about total number of detection lines, for evaluation of correct hose sockets.

Total number of detection lines	Recommended air pipe size		Art.-No. for hose socket c/w 2 hose clamps	Art.-No. for PVC extension adapter
	• from farrest SDS-Panel to fan unit	• from fan unit outlet to end of line		
	below 5 m	above 5 m		
1 - 10	2½" (DN 65)	2½" (DN 65)	BG02.032 (4 pcs.)	
11 - 18	2½" (DN 65)	3" (DN 80)	BG02.032 (4 pcs.)	
19 - 24	3" (DN 80)	3" (DN 80)	BG02.031 (4 pcs.)	Z04.020 (2 pcs.)

Hose socket c/w clamps (inner diameter)
supplied by safetec

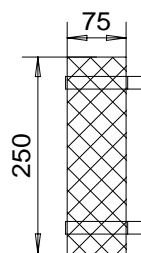
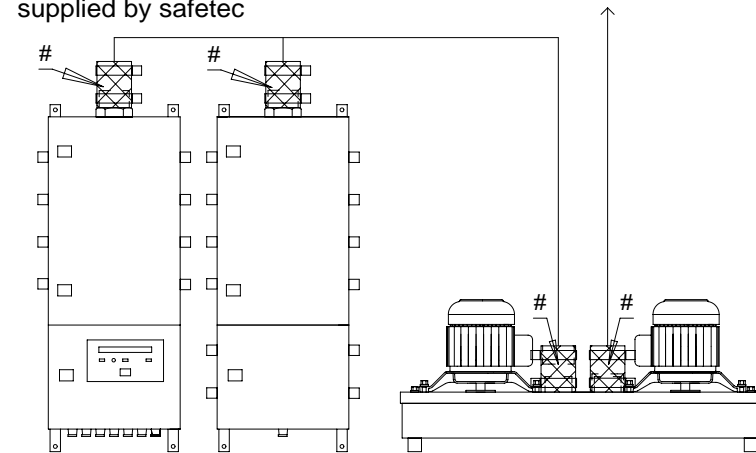

Art.-No.:
hose socket
with clamps
BG02.032

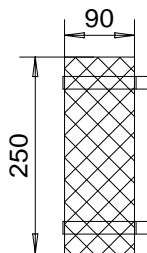

Art.-No.:
hose socket
with clamps
BG02.031

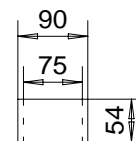

Art.-No.:
PVC extension
adapter
Z04.020

Rev. 4	23.08.07	PE	Maßstab
Gepr.	23.08.07	KB	1:1
Bearb.	28.03.04	HZ	

Art.No. Description Type	Remarks	Outline
--------------------------------	---------	---------

1. Basic Components

<p>SDS02.100</p> <p>Smoke Detection Panel 0-Line</p> <p>SDS-0, 220/230V</p>	<p>Smoke Detection Panel without internal detection lines. Dimensions of enclosure without fittings (H x B x D): 300 x 380 x 210 mm Weight: 12 kg Power Supply: 2 x 220/230VAC 400W</p>	
<p>SDS02.104</p> <p>Smoke Detection Panel 4-Line</p> <p>SDS-4, 220/230V</p>	<p>Smoke Detection Panel with 1-4 internal detection lines. Dimensions of enclosure without fittings (H x B x D): 600 x 380 x 210 mm Weight: 26 kg (4 lines) Power Supply: 2 x 220/230VAC 400W</p> <p>Art.Nos.:</p> <p>SDS02.101 Detection Panel 1-Line 220/230 V 23kg SDS02.102 Detection Panel 2-Line 220/230 V 24kg SDS02.103 Detection Panel 3-Line 220/230 V 25kg SDS02.104 Detection Panel 4-Line 220/230 V 26kg</p>	
<p>SDS02.108</p> <p>Smoke Detection Panel 8-Line</p> <p>SDS-8, 220/230V</p>	<p>Smoke Detection Panel with 5-8 internal detection lines. Dimensions of enclosure without fittings (H x B x D): 900 x 380 x 210 mm Power Supply: 2 x 220/230VAC 400W</p> <p>Art.Nos.:</p> <p>SDS02.105 Detection Panel 5-Line 220/230 V 44kg SDS02.106 Detection Panel 6-Line 220/230 V 45kg SDS02.107 Detection Panel 7-Line 220/230 V 46kg SDS02.108 Detection Panel 8-Line 220/230 V 47kg</p>	
<p>SDS02.112</p> <p>Smoke Detection Panel 12-Line</p> <p>SDS-12,220/230V</p>	<p>Smoke Detection Panel with 9-12 internal detection lines. Dimensions of enclosure without fittings (H x B x D): 1200 x 380 x 210 mm Power Supply: 2 x 220/230VAC 400W</p> <p>Art.Nos.:</p> <p>SDS02.109 Detection Panel 9-Line 220/230 V 57kg SDS02.110 Detection Panel 10-Line 220/230 V 58kg SDS02.111 Detection Panel 11-Line 220/230 V 59kg SDS02.112 Detection Panel 12-Line 220/230 V 60kg</p>	





Art.No. Description Type	Remarks	Outline																
<p>SDS02.120</p> <p>Smoke Detection Panel, 0-Line</p> <p>SDS-0,110/115V</p>	<p>Smoke Detection Panel without internal detection lines. Dimensions of enclosure without fittings (H x B x D): 300 x 380 x 210 mm Weight: 12 kg Power Supply: 2 x 110VAC 400W</p>																	
<p>SDS02.124</p> <p>Smoke Detection Panel 4-Line</p> <p>SDS-4,110/115V</p>	<p>Smoke Detection Panel with 1-4 internal detection lines. Dimensions of enclosure without fittings (H x B x D): 600 x 380 x 210 mm Power Supply: 2 x 110VAC 400W</p> <p>Art.Nos.:</p> <table border="0"> <tr> <td>SDS02.121</td> <td>Detection Panel 1-Line</td> <td>110 V</td> <td>23kg</td> </tr> <tr> <td>SDS02.122</td> <td>Detection Panel 2-Line</td> <td>110 V</td> <td>24kg</td> </tr> <tr> <td>SDS02.123</td> <td>Detection Panel 3-Line</td> <td>110 V</td> <td>25kg</td> </tr> <tr> <td>SDS02.124</td> <td>Detection Panel 4-Line</td> <td>110 V</td> <td>26kg</td> </tr> </table>	SDS02.121	Detection Panel 1-Line	110 V	23kg	SDS02.122	Detection Panel 2-Line	110 V	24kg	SDS02.123	Detection Panel 3-Line	110 V	25kg	SDS02.124	Detection Panel 4-Line	110 V	26kg	
SDS02.121	Detection Panel 1-Line	110 V	23kg															
SDS02.122	Detection Panel 2-Line	110 V	24kg															
SDS02.123	Detection Panel 3-Line	110 V	25kg															
SDS02.124	Detection Panel 4-Line	110 V	26kg															
<p>SDS02.128</p> <p>Smoke Detection Panel 8-Line</p> <p>SDS-8,110/115V</p>	<p>Smoke Detection Panel with 5-8 internal detection lines. Dimensions of enclosure without fittings (H x B x D): 900 x 380 x 210 mm Power Supply: 2 x 110VAC 400W</p> <p>Art.Nos.:</p> <table border="0"> <tr> <td>SDS02.125</td> <td>Detection Panel 5-Line</td> <td>110 V</td> <td>44kg</td> </tr> <tr> <td>SDS02.126</td> <td>Detection Panel 6-Line</td> <td>110 V</td> <td>45kg</td> </tr> <tr> <td>SDS02.127</td> <td>Detection Panel 7-Line</td> <td>110 V</td> <td>46kg</td> </tr> <tr> <td>SDS02.128</td> <td>Detection Panel 8-Line</td> <td>110 V</td> <td>47kg</td> </tr> </table>	SDS02.125	Detection Panel 5-Line	110 V	44kg	SDS02.126	Detection Panel 6-Line	110 V	45kg	SDS02.127	Detection Panel 7-Line	110 V	46kg	SDS02.128	Detection Panel 8-Line	110 V	47kg	
SDS02.125	Detection Panel 5-Line	110 V	44kg															
SDS02.126	Detection Panel 6-Line	110 V	45kg															
SDS02.127	Detection Panel 7-Line	110 V	46kg															
SDS02.128	Detection Panel 8-Line	110 V	47kg															
<p>SDS02.132</p> <p>Smoke Detection Panel 12-Line</p> <p>SDS-12,110/115V</p>	<p>Smoke Detection Panel with 9-12 internal detection lines. Dimensions of enclosure without fittings (H x B x D): 1200 x 380 x 210 mm Power Supply: 2 x 110VAC 400W</p> <p>Art.Nos.:</p> <table border="0"> <tr> <td>SDS02.129</td> <td>Detection Panel 9-Line</td> <td>110 V</td> <td>57kg</td> </tr> <tr> <td>SDS02.130</td> <td>Detection Panel 10-Line</td> <td>110 V</td> <td>58kg</td> </tr> <tr> <td>SDS02.131</td> <td>Detection Panel 11-Line</td> <td>110 V</td> <td>59kg</td> </tr> <tr> <td>SDS02.132</td> <td>Detection Panel 12-Line</td> <td>110 V</td> <td>60kg</td> </tr> </table>	SDS02.129	Detection Panel 9-Line	110 V	57kg	SDS02.130	Detection Panel 10-Line	110 V	58kg	SDS02.131	Detection Panel 11-Line	110 V	59kg	SDS02.132	Detection Panel 12-Line	110 V	60kg	
SDS02.129	Detection Panel 9-Line	110 V	57kg															
SDS02.130	Detection Panel 10-Line	110 V	58kg															
SDS02.131	Detection Panel 11-Line	110 V	59kg															
SDS02.132	Detection Panel 12-Line	110 V	60kg															
<p>SDS02.204</p> <p>Extension Panel 4-Line</p> <p>SDS-E4</p>	<p>Extends a smoke detection panel with 1-4 detection lines. Dimensions of enclosure without fittings (H x B x D): 300 x 380 x 210 mm</p> <p>Art.Nos.:</p> <table border="0"> <tr> <td>SDS02.201</td> <td>Extension Panel 1-line</td> <td>13kg</td> </tr> <tr> <td>SDS02.202</td> <td>Extension Panel 2-line</td> <td>14kg</td> </tr> <tr> <td>SDS02.203</td> <td>Extension Panel 3-line</td> <td>15kg</td> </tr> <tr> <td>SDS02.204</td> <td>Extension Panel 4-line</td> <td>16kg</td> </tr> </table>	SDS02.201	Extension Panel 1-line	13kg	SDS02.202	Extension Panel 2-line	14kg	SDS02.203	Extension Panel 3-line	15kg	SDS02.204	Extension Panel 4-line	16kg					
SDS02.201	Extension Panel 1-line	13kg																
SDS02.202	Extension Panel 2-line	14kg																
SDS02.203	Extension Panel 3-line	15kg																
SDS02.204	Extension Panel 4-line	16kg																

Art.No. Description Type	Remarks	Outline
<p>SDS02.208</p> <p>Extension Panel 8-Line</p> <p>SDS-E8</p>	<p>Extends a smoke detection panel with 5-8 detection lines.</p> <p>Dimensions of enclosure without fittings (H x B x D): 600 x 380 x 210 mm</p> <p>Art.Nos.:</p> <p>SDS02.205 Extension Panel 5-line 30kg SDS02.206 Extension Panel 6-line 31kg SDS02.207 Extension Panel 7-line 32kg SDS02.208 Extension Panel 8-line 33kg</p>	
<p>SDS02.212</p> <p>Extension Panel 12-Line</p> <p>SDS-E12</p>	<p>Extends a smoke detection panel with 9-12 detection lines.</p> <p>Dimensions of enclosure without fittings (H x B x D): 900 x 380 x 210 mm</p> <p>Art.Nos.:</p> <p>SDS02.209 Extension Panel 9-line 45kg SDS02.210 Extension Panel 10-line 46kg SDS02.211 Extension Panel 11-line 47kg SDS02.212 Extension Panel 12-line 48kg</p>	
<p>SDS02.216</p> <p>Extension Panel 16-Line</p> <p>SDS-E16</p>	<p>Extends a smoke detection panel with 13-16 detection lines.</p> <p>Dimensions of enclosure without fittings (H x B x D): 1200 x 380 x 210 mm</p> <p>Art.Nos.:</p> <p>SDS02.213 Extension Panel 13-line 62kg SDS02.214 Extension Panel 14-line 63kg SDS02.215 Extension Panel 15-line 64kg SDS02.216 Extension Panel 16-line 65kg</p>	
<p>SDS02.300</p> <p>Repeater Panel for Wall Mounting</p> <p>SDS-R48/G</p>	<p>Required for remote indication of fire and fault alarms.</p> <p>Dimensions of enclosure without fittings (H x B x D): 122 x 220 x 80 mm</p> <p>Weight: 1,8kg</p>	
<p>SDS02.301</p> <p>Repeater Panel for Console Mounting</p> <p>SDS-R48/P</p>	<p>Required for remote indication of fire and fault alarms.</p> <p>Dimensions of enclosure without fittings (H x B x D): 122 x 220 x 60 mm</p> <p>Weight: 1,8kg</p>	





Art.No. Description Type	Remarks	Outline
<p>SDS02.440</p> <p>Fan Unit SDS0440</p> <p>220/230V,50/60Hz</p>	<p>Standard - type Prime mover = electric motor Fan wheel directly driven by shaft</p> <p>Dimensions (H x B x D): 337 x 886 x 428 mm Weight: 45kg</p> <p>Power Supply: 220/230VAC; 50/60Hz; 370W@50Hz, 440W@60Hz</p>	
<p>SDS02.441</p> <p>Fan Unit SDS0441</p> <p>110/115V, 60Hz</p>	<p>Standard - type Prime mover = electric motor Fan wheel directly driven by shaft</p> <p>Dimensions (H x B x D): 337 x 886 x 428 mm Weight: 45kg</p> <p>Power Supply: 110/115VAC; 60Hz; 440W</p>	
<p>SDS02.445</p> <p>Fan Unit SDS-M0440 with Housing</p> <p>220/230V, 50/60Hz</p>	<p>Fan Unit SDS02.440 in special GFK housing.</p> <p>Colour: White (RAL 9010) Weight: 63 Kg Dimensions: 123 x 64 x 38</p>	
<p>SDS02.446</p> <p>Fan Unit SDS-M0441 with Housing</p> <p>110/120V, 60Hz</p>	<p>Fan Unit SDS02.441 in special GFK housing.</p> <p>Colour: White (RAL 9010) Weight: 63 Kg Dimensions: 123 x 64 x 38</p>	

Art.No. Description Type	Remarks	Outline
--------------------------------	---------	---------

2. Accessories

B30.001	<p>Produces smoke with special tobacco. The strength of the smoke generation can be controlled with the fan. Recommended for smoke tests with cargo hold smoke detection systems.</p> <p>Dimensions: 22 x 10 cm Weight: 734g</p>	
Smoke Generator with integrated Fan		
Vulkan		
B30.004	<p>Helps to light the tobacco in the smoke generator</p> <p>Dimensions: 13 x 9,5 x 1 cm Weight: 40g</p>	
Starter for Tobacco		
B30.006	<p>To be used in smoke generator B30.001.</p> <p>Weight: 500g</p>	
Tobakko for Smoke Generator, 500 g		
medium		
BG01.930	<p>Suitable for connection of flexible PVC-hose (Z02.002) to some types of 3-way valves, consisting of:</p> <ul style="list-style-type: none"> - straight connector for PVC-hose (Z02.002) - sealing ring, fibre - reduction nipple 3/4" x 1/2", brass - sealing ring, copper <p>Weight: 104g</p>	
Hose Fitting 3/4" male thread		
for PVC-hose 13/20mm		

Art.No. Description Type	Remarks	Outline
<p>BG02.03x</p> <p>PVC-Hose Socket with Clamps</p>	<p>The size of PVC-Hose Socket with Clamps and Reductions depends on total number of detection lines, see the drawing BG02.03x.</p> <p>Suitable for:</p> <ol style="list-style-type: none"> 1. connection of air inlet- and outlet pipes (steel pipe size, see the drawing BG02.03x) to air fan units SDS01.420 / SDS01.430 / SDS01.440 2. connection of air outlet pipe (steel pipe size, see the drawing BG02.03x) to smoke detection panels / extension panel 	
<p>BG02.861</p> <p>Prefilter for SDS-System</p> <p>SDS-2/6, SDS-48</p>	<p>Special Filters to prevent soiled Smoke Detectors. Suitable in front of 3-Way-Valves.</p> <p>Weight: 350g Outer diam.: 60 mm Length: 200 mm</p>	
<p>BG02.908</p> <p>Fire Alarm Relay Module for max. 8 Lines</p> <p>System: SDS-48</p>	<p>The Fire Alarm Relay Module offers 8 voltage-free contacts for individual indication of fire alarm in each line. It can be placed into the smoke detection panel.</p>	
<p>DOK02.041</p> <p>Manual for SDS-48, German Version</p> <p>SDS-48</p>	<p>Size: DIN A4 Weight: ca. 330g</p>	<p>Rauchmeldesystem SDS-48</p> <p><small>File: Schiffskabinen nach SOLAS Chapter II-2 Regulation 13-1</small></p>  <p>Anwender - Handbuch</p>
<p>DOK02.051</p> <p>Manual for SDS48, English Version</p> <p>SDS-48</p>	<p>Size: DIN A4 Weight: ca. 330g</p>	<p>Smoke Detection System SDS48</p> <p><small>For Cargo Holds Onboard Ships acc. to SOLAS Chapter II-2 Regulation 13-1</small></p>  <p>Operating Manual</p>

Art.No. Description Type	Remarks	Outline
<p>E02.005</p> <p>External Sounder</p> <p>B/C 28</p>	<p>The external sounder may be mounted in a prepared blind boring in the smoke detection panel. If the sounder shall be mounted to a repeater panel, please order repeater panel together with the external sounder.</p> <p>Dimensions: 43 x 48 mm Weight: 40g Loudness: 85 dB/1m</p>	
<p>E08.803</p> <p>Aerosol Test Gas</p> <p>250 ml</p>	<p>The test spray allows simulation of smoke to test a smoke detector.</p> <p>Content: 250 ml Weight: 250g</p>	
<p>G05.002</p> <p>Door Arret</p> <p>SZ 2519</p>	<p>Suitable to arret front doors of smoke detection panels and extension panels in open position (1 pce per each door required)</p> <p>Weight (set): 218g</p>	
<p>Z01.002</p> <p>Pipe Connector 3/4"female thread</p> <p>1/2a x 3/4i</p>	<p>Allows direct connection of DN20 steel pipe to the smoke detection panel and extension unit. Use it instead of the connection for flexible PVC - hose.</p> <p>Weight: 72g</p>	
<p>Z02.002</p> <p>Flexible Hose (PVC), inner diam. 13 mm</p> <p>Guttasyn</p>	<p>Material: PVC 8020 / 7020 Color: 29101 transparent nominal pressure at 20°C: 10 bar</p> <p>Suitable for connection between air sample inlets of smoke detection panels / extension panels / 3-way valves.</p> <p>Weight per m: 229g</p>	

Art.No. Description Type	Remarks	Outline
<p>Z02.004</p> <p>Flexible Hose with Spiral, inner diam.50 mm</p> <p>Airduc PVC 343, gray</p>	<p>Suitable for connection between smoke detection panels and air fan units, when steel pipe laying causes problems (to be approved by class surveyor).</p> <p>Material: - PVC - steel spiral</p> <p>Colour: gray</p> <p>Weight per m: 541g</p>	
<p>Z02.006</p> <p>Flexible Hose green, inner diam.: 50mm</p> <p>Heliflex</p>	<p>Suitable for connection between smoke detection panels and air fan units, when steel pipe laying causes problems (to be approved by class surveyor).</p> <p>Material: - PVC - spiral</p> <p>Colour: green</p> <p>Weight per m: 500g</p>	
<p>Z02.014</p> <p>Hose Clamp, 50-70 mm</p> <p>galvanized</p>	<p>50 - 70 mm diameter, suitable for connection of PVC-hoses Z02.006, Z02.070 or for other purposes.</p> <p>Material: steel, galvanized</p> <p>Weight: 40g</p>	
<p>Z02.017</p> <p>Hose Clamp, 70-90 mm</p> <p>galvanized</p>	<p>70-90 mm diameter, suitable for connection of PVC-hose Z02.071 or for other purposes.</p> <p>Material: steel, galvanized</p> <p>Weight: 45g</p>	
<p>Z02.018</p> <p>Hose Clamp, 90-110 mm</p> <p>galvanized</p>	<p>90-110 mm diameter, suitable for connection of PVC-hose Z02.072 or for other purposes.</p> <p>Material: steel, galvanized</p> <p>Weight: 50g</p>	

Art.No. Description Type	Remarks	Outline
<p>Z02.070</p> <p>Flexible Hose green, inner diam.: 63mm</p> <p>Heliflex</p>	<p>Suitable for connection between smoke detection panels and air fan units, when steel pipe laying causes problems (to be approved by class surveyor).</p> <p>Material: - PVC - steel spiral Colour: green Weight per m: 500g</p>	
<p>Z02.071</p> <p>Flexible Hose green, inner diam.: 75mm</p> <p>Heliflex</p>	<p>Suitable for connection between smoke detection panels and air fan units, when steel pipe laying causes problems (to be approved by class surveyor).</p> <p>Material: - PVC - steel spiral Colour: green Weight per m: 541g</p>	
<p>Z02.072</p> <p>Flexible Hose green, inner diam.: 90mm</p> <p>Heliflex</p>	<p>Suitable for connection between smoke detection panels and air fan units, when steel pipe laying causes problems (to be approved by class surveyor).</p> <p>Material: - PVC - steel spiral Colour: green Weight per m: 541g</p>	
<p>Z03.008</p> <p>Adapter Nipple</p> <p>75/63 mm x 2 1/2"AG</p>	<p>Air outlet connection of smoke detection panels and extension units (included in standart scope of supply).</p> <p>Weight: 150g Lenght: 88 mm</p>	
<p>Z04.003</p> <p>PVC-Elbow 90°</p> <p>50 mm inner diam.</p>	<p>Suitable for DN40 pipe installation between smoke detection panels and fan-unit (alternatively to steel piping).</p> <p>Material: PVC Weight: 150g</p>	



Art.No. Description Type	Remarks	Outline
<p>Z04.004</p> <p>PVC-Elbow 90°</p> <p>63 mm inner diam.</p>	<p>Suitable for DN50 pipe installation between smoke detection panels and fan-unit (alternatively to steel piping).</p> <p>Material: PVC Weight: 170g</p>	
<p>Z04.005</p> <p>PVC-Elbow 90°</p> <p>75 mm inner diam.</p>	<p>Suitable for DN65 pipe installation between smoke detection panels and fan-unit (alternatively to steel piping).</p> <p>Material: PVC Weight: 200g</p>	
<p>Z04.006</p> <p>PVC-Elbow 90°</p> <p>90 mm inner diam.</p>	<p>Suitable for DN80 pipe installation between smoke detection panels and fan-unit (alternatively to steel piping).</p> <p>Material: PVC Weight: 250g</p>	
<p>Z04.010</p> <p>PVC-Tee</p> <p>50 mm inner diam.</p>	<p>Suitable for DN40 pipe installation between smoke detection panels and fan-unit (alternatively to steel piping).</p> <p>Material: PVC Weight: 200g</p>	
<p>Z04.011</p> <p>PVC-Tee</p> <p>63 mm inner diam.</p>	<p>Suitable for DN50 pipe installation between smoke detection panels and fan-unit (alternatively to steel piping).</p> <p>Material: PVC Weight: 220g</p>	

Art.No. Description Type	Remarks	Outline
<p>Z04.012</p> <p>PVC-Tee</p> <p>75 mm inner diam.</p>	<p>Suitable for DN65 pipe installation between smoke detection panels and fan-unit (alternatively to steel piping).</p> <p>Material: PVC Weight: 250g</p>	
<p>Z04.013</p> <p>PVC-Tee</p> <p>90 mm inner diam.</p>	<p>Suitable for DN80 pipe installation between smoke detection panels and fan-unit (alternatively to steel piping).</p> <p>Material: PVC Weight: 300g</p>	
<p>Z04.015</p> <p>PVC-Reduction short</p> <p>63-50 mm</p>	<p>Fitting suitable between SDS-48 and flexible hose</p>	
<p>Z04.016</p> <p>PVC-Reduction, inner diameter 75 mm</p> <p>75 mm to DN50</p>	<p>Fitting suitable between fan-unit and flexible hose</p>	
<p>Z04.020</p> <p>PVC-Extension, GF, short</p> <p>75 mm to 90 mm</p>	<p>Fitting suitable between SDS-48 and flexible hose</p>	

Art.No. Description Type	Remarks	Outline
<p>Z05.001</p> <p>PVC-Pipe, outer diam. 90mm</p> <p>for DN80 pipes</p>	<p>Suitable adaptor pipe fitting to connect DN80 steel pipes to smoke detection panels and extension units.</p> <p>Material: PVC Weight: 70g Length: 80mm</p>	
<p>Z05.002</p> <p>PVC-Pipe DN80 - 90x4,3 mm 6m-length</p> <p>6m-length</p>	<p>Suitable for pipe installation between smoke detection panels and fan-unit (alternativly to steel piping).</p> <p>Material: PVC Weight per m: 1100g outer diam.: 90 mm</p>	
<p>Z05.003</p> <p>PVC-Pipe DN40 - 50x3,7 mm</p> <p>5m-length</p>	<p>Suitable for pipe installation between smoke detection panels and fan-unit (alternativly to steel piping).</p> <p>Material: PVC Weight per m: 700g outer diam.: 50mm</p>	
<p>Z05.004</p> <p>PVC-Pipe DN50 - 63x3,6 mm</p> <p>6m-length</p>	<p>Suitable for pipe installation between smoke detection panels and fan-unit (alternativly to steel piping).</p> <p>Material: PVC Weight per m: 800g outer diam.: 63mm</p>	
<p>Z05.005</p> <p>PVC-Pipe, outer diam. 75mm</p> <p>for DN65 pipes</p>	<p>Suitable adaptor pipe fitting to connect DN65 steel pipes to smoke detection panels and extension units.</p> <p>Material: PVC Weight: 70g Length: 80mm</p>	





Art.No. Description Type	Remarks	Outline
<p>Z05.006</p> <p>PVC-Pipe, outer diam. 50mm</p> <p>for DN40 pipes</p>	<p>Suitable adaptor pipe fitting to connect DN40 steel pipes to smoke detection panels and extension units.</p> <p>Material: PVC Weight: 60g Length: 80mm</p>	
<p>Z05.007</p> <p>PVC-Pipe, outer diam. 63mm</p> <p>for DN50 pipes</p>	<p>Suitable adaptor pipe fitting to connect DN50 steel pipes to smoke detection panels and extension units.</p> <p>Material: PVC Weight: 70g Length: 80mm</p>	
<p>Z05.008</p> <p>PVC-Pipe DN40 - 50x3,7 mm</p> <p>1m-length</p>	<p>Suitable for pipe installation between smoke detection panels and fan-unit (alternatively to steel piping).</p> <p>Material: PVC Weight per m: 700g outer diam.: 50mm</p>	
<p>Z05.009</p> <p>PVC Socket</p> <p>inner diam. 50mm</p>	<p>Suitable adaptor pipe fitting to connect DN40 steel pipes.</p> <p>Material: PVC Weight: 70g Length: 65mm</p>	
<p>Z05.012</p> <p>PVC pipe socket</p> <p>inner diam. 63mm</p>	<p>Suitable adaptor pipe fitting to connect DN50 steel pipes.</p> <p>Material: PVC Weight: 140g Length: 80mm</p>	





Art.No. Description Type	Remarks	Outline
<p>Z05.013</p> <p>PVC pipe socket</p> <p>inner diam. 75 mm</p>	<p>Suitable adaptor pipe fitting to connect DN65 steel pipes.</p> <p>Material: PVC Weight: 250g Length: 92mm</p>	
<p>Z05.018</p> <p>PVC pipe socket</p> <p>inner diam. 90 mm</p>	<p>Suitable adaptor pipe fitting to connect DN80 steel pipes.</p> <p>Material: PVC Weight: 390g Length: 106mm</p>	
<p>Z05.025</p> <p>PVC-Pipe DN65 - 75x3,6 mm</p> <p>5m-length</p>	<p>Suitable for pipe installation between smoke detection panels and fan-unit (alternativly to steel piping).</p> <p>Material: PVC Weight per m: 900g outer diam.: 75mm</p>	
<p>Z07.002</p> <p>Vent Check Valve DN 50</p> <p>Bolero</p>	<p>Suitable for installation at end of air sampling line to atmosphere.</p> <p>O.D. x t = 60,3 x 6,3 DIN 2448 / 1629 ST 35 Weight: 5,8kg</p>	
<p>Z12.010</p> <p>3-Way-Valve</p> <p>DN20 / PN160</p>	<p>Suitable armature switch over from air suction to CO2 - discharge direction in case of fire.</p> <p>Weight: 1624g</p>	





Art.No. Description Type	Remarks	Outline
<p>Z90.001</p> <p>PVC-Elbow 90°, with sockets</p> <p>outer diam. 50mm</p>	<p>Suitable adaptor pipe fitting to connect 1 1/2" steel pipes to smoke detection panels and extension units.</p> <p>Material: PVC Weight: 280g</p>	
<p>Z90.010</p> <p>PVC-Tee, with hose sockets</p> <p>outer diam. 50mm</p>	<p>Suitable adaptor pipe fitting to connect 1 1/2" steel pipes to smoke detection panels and extension units.</p> <p>Material: PVC Weight: 400g</p>	
<p>Z90.012</p> <p>PVC-Reduction</p> <p>75mm to DN40</p>	<p>Fitting consisting of Z04.016 and Z05.006</p>	

3. Spare Parts

<p>BG02.001</p> <p>Spare Parts Set, stowed inside SDS Panel</p> <p>System SDS-48</p>	<p>Content:</p> <p>10 pcs fuse 6,3 A t, time-lag, art.no. F03.035 10 pcs fuse 250 mA t, time-lag, art.no. F03.111 2 pcs sealing for motor shaft, art.no. FAN02.035 1 pc spare key for SDS-48 G04.100 3 pcs blind glands M20x1,5, art.no. W40.720 2 pcs blind glands M25x1,5, art.no. W40.725</p> <p>Weight: 115g</p>	
---	---	---

Art.No. Description Type	Remarks	Outline
<p>BG02.301</p> <p>Adapter Module for Repeater Panel</p> <p>System SDS-48</p>	<p>PCB in repeater panel with screwed terminals for cable connections and flatcable - connector for indication - / control module The adapter - pcb contains relays and terminals for fire, fault and general alarm as well as terminals for external buzzer.</p> <p>Dimensions: 110 x 60 mm Weight: 70g</p>	
<p>BG02.500</p> <p>Control Module for Smoke Detection Panel</p> <p>System SDS-48</p>	<p>The control module is mounted behind the front door of the smoke detection panel. It contains LC - display, LEDs and push - button for the operation of the system.</p> <p>Dimension: 182 x 105 x 38 Weight: 270g</p>	
<p>BG02.510</p> <p>Control Module for Repeater Panel</p> <p>System SDS-48</p>	<p>The control module is mounted behind the front cover of the repeater panel. It contains LC - display, LEDs and push - button for the operation of the system.</p> <p>Dimension: 182 x 105 x 38 Weight: 270g</p>	
<p>BG02.600</p> <p>Power Supply Module 220/230V</p> <p>System SDS-48</p>	<p>The power supply unit is mounted inside the smoke detection panel. It contains all power connections for main and emergency supply and for the fan unit as well as fuses and terminals for relay contacts.</p> <p>Dimensions: 187 x 167 x 55 mm Weight: 1,2kg</p>	
<p>BG02.610</p> <p>Power Supply Module 110V/ 115V</p> <p>System SDS-48</p>	<p>The power supply unit is mounted inside the smoke detection panel. It contains all power connections for main and emergency supply and for the fan unit as well as fuses and terminals for relay contacts.</p> <p>Dimensions: 187 x 167 x 55 mm Weight: 1,2kg</p> <p>Only for 110V/ 115V supply!</p>	

Art.No. Description Type	Remarks	Outline
<p>BG02.810</p> <p>Detector Connection Module, 4 Lines + Extension</p> <p>System SDS-48</p>	<p>PCB to connect up to 4 smoke detectors and airflow indicators.</p> <p>Dimensions: 244 x 46 mm Weight: 72g</p>	
<p>BG02.820</p> <p>Detector Connection Module, 8 Lines + Extension</p> <p>System SDS-48</p>	<p>PCB to connect up to 8 smoke detectors and airflow indicators.</p> <p>Dimensions: 488 x 46 mm Weight: 136g</p>	
<p>E01.003</p> <p>Airflow Indicator (Pressure Switch)</p> <p>Type 605</p>	<p>The airflow indicator (pressure switch 0,3 mbar) is mounted in the upper enclosures of the smoke detection panels and extension units.</p> <p>Dimensions: D=81 mm H=74 mm Weight: 120g</p> <p>Remark: If the predecessor E01.001 shall be replaced, please order plug and cable BG02.090, too.</p>	
<p>E06.101</p> <p>Galvanic Isolator EEx, 1 Channel, for SDS-48</p> <p>KFD0-CS-Ex1.54</p>	<p>The galvanic isolator serves as a safety barrier for intrinsically safe operation of the smoke detectors and airflow indicators. This type contains 1 channel.</p> <p>Dimensions: 112 x 93 x 20 mm Weight: ca. 100g</p>	
<p>E06.102</p> <p>Galvanic Isolator EEx, 2 Channels, for SDS-48</p> <p>KFD0-CS-Ex2.54</p>	<p>The galvanic isolator serves as a safety barrier for intrinsically safe operation of the smoke detectors and airflow indicators. This type contains 2 channels.</p> <p>Dimensions: 112 x 93 x 20 mm Weight: ca. 100g</p>	

Art.No. Description Type	Remarks	Outline
<p>E20.002</p> <p>Optical Smoke Detector XP95 I.S.</p> <p>System SDS-48</p>	<p>The smoke detectors are located in the detector boxes of the smoke detection panel and the extension panel.</p> <p>Dimensions: 100 x 50 mm (including socket) Weight: 161g (including socket)</p>	
<p>E20.004</p> <p>Socket for Smoke Detector</p> <p>System SDS-48</p>	<p>The sockets for smoke detectors are located in the detector boxes of the smoke detection panel and the extension panel.</p> <p>Dimensions: 100 x 50 (including smoke detector) Weight: 161g (including smoke detector)</p>	
<p>FAN02.017</p> <p>Impeller, Steel, for SDS02.440/441</p>	<p>Suitable for installation on FAN-unit SDS02.440 and SDS02.441.</p> <p>Dimensions: Diam. 300mm Weight : 2,2 Kg</p>	
<p>FAN02.035</p> <p>Sealing for motor shaft, for SDS02.440</p> <p>PTFE</p>	<p>Suitable for installation on FAN-unit SDS02.440 and SDS02.441</p> <p>Weight: 8g</p>	
<p>FAN02.036</p> <p>Ball bearing for Fan Unit SDS-M0430 / M0440</p> <p>Type 6202 2Z C3</p>	<p>For fan unit SDS-M0430 with motor type "Hanning" Location: opposite of shaft side</p> <p>Dimensions: D = 35, H = 10 mm Weight: 50g</p>	

Art.No. Description Type	Remarks	Outline
FAN02.037	for fan unit SDS-M0430 with motor type "Hanning". Location: shaft side	
Ball bearing for Fan Unit SDS-M0430 / M0440	Dimensions: D = 35, H = 10 mm Weight: 50g	
Type 6204 2Z C3		
FAN02.114	Suitable for installation on electric motor FAN02.131.	
Capacitor for Fan Unit SDS-M0441, Motor: Hanning	length: 130 mm Diam.: 45 mm	
40 µF 240VAC		
FAN02.116	Suitable for installation on electric motor FAN02.121.	
Capacitor for Fan Unit SDS-M0440	Length: 100 mm Diam.: 35mm Weight: 50g	
10 µF450VAC, P2, Alu		
FAN02.121	Suitable for installation on SDS 02.440.	
E-Motor, 1Ph. 230V, 50/60Hz, Hanning, for Fan Unit	Diam.: 350 mm Weight: 6,1 Kg	
E7KC2B5-7-378		
FAN02.131	Suitable for installation on SDS02.441.	
E-Motor, 1 Ph. 110V, 60Hz	Diam.: 350 mm Weight: 6,1 Kg	
E7KC2B5-7-387		