



Temperature Converter with Trip Values

KFD2-GUT-Ex1.D

- 1-channel isolated barrier
- 24 V DC supply (Power Rail)
- Thermocouple, RTD, potentiometer or voltage input
- Redundant TC input
- Current output 0/4 mA ... 20 mA
- 2 relay contact outputs
- Configurable by PACTware or keypad
- Line fault (LFD) and sensor burnout detection
- Up to SIL 2 acc. to IEC/EN 61508 / IEC/EN 61511



Function

This isolated barrier is used for intrinsic safety applications. The device converts the signal of a resistance thermometer, thermocouple, potentiometer, or voltage source to a proportional output current. It also provides a relay trip value. The removable terminal block K-CJC-** is available as an accessory for internal cold junction compensation of thermocouples. A fault is signaled by LEDs acc. to NAMUR NE44 and a separate collective error message output. The device is easily configured by the use of the PACTware configuration software. For additional information, refer to the manual and www.pepperl-fuchs.com.

Connection

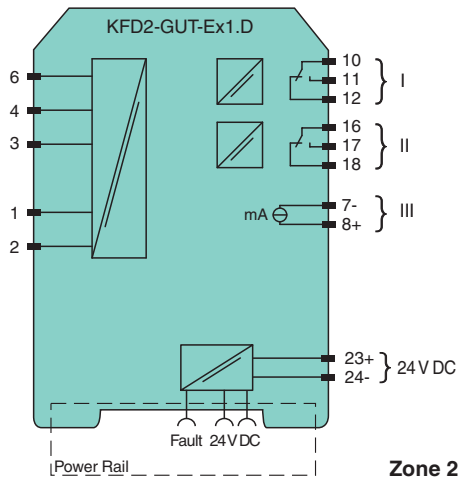
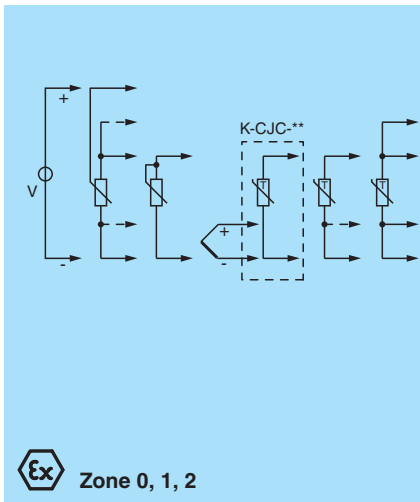

Technical Data

General specifications	
Signal type	Analog input
Functional safety related parameters	
Safety Integrity Level (SIL)	SIL 2
Supply	
Connection	terminals 23+, 24- or power feed module/Power Rail
Rated voltage	U_r 20 ... 30 V DC
Rated current	I_r approx. 100 mA
Power dissipation/power consumption	≤ 2 W / 2.2 W

Release date: 2023-01-03 Date of issue: 2023-01-03 Filename: 231225_eng.pdf

Refer to "General Notes Relating to Pepperl+Fuchs Product Information".

Pepperl+Fuchs Group
www.pepperl-fuchs.com

USA: +1 330 486 0002
pa-info@us.pepperl-fuchs.com

Germany: +49 621 776 2222
pa-info@de.pepperl-fuchs.com

Singapore: +65 6779 9091
pa-info@sg.pepperl-fuchs.com



Technical Data

Interface		
Programming interface		programming socket
Input		
Connection side		field side
Connection		terminals 1, 2, 3, 4, 6
RTD		Pt100, Pt500, Pt1000, Ni100, Ni1000
Types of measuring		2-, 3-, 4-wire technology
Lead resistance		max. 50 Ω
Measurement loop monitoring		sensor breakage, sensor short-circuit
Thermocouples		type B, E, J, K, L, N, R, S, T (IEC 584-1: 1995)
Cold junction compensation		external and internal
Measurement loop monitoring		sensor breakage
Potentiometer		0.8 ... 20 kΩ
Types of measuring		2-, 3-, 5-wire technology
Voltage		0 ... 10 V, 2 ... 10 V, 0 ... 1 V, -100 ... 100 mV
Input resistance		≥ 250 kΩ (0 ... 10 V) min. 1 MΩ (0 ... 1 V, -100 ... 100 mV)
Measuring current		approx. 400 μA with resistance measuring sensor
Output		
Connection side		control side
Connection		output I: terminals 10, 11, 12 output II: terminals 16, 17, 18 output III: terminals 8+, 7-
Output I, II		relay
Contact loading		250 V AC / 2 A / $\cos \phi \geq 0.7$; 40 DC / 2 A
Mechanical life		5 x 10 ⁷ switching cycles
Energized/De-energized delay		approx. 20 ms / approx. 20 ms
Output III		Analog current output
Current range		0 ... 20 mA or 4 ... 20 mA
Open loop voltage		max. 24 V DC
Load		max. 650 Ω
Fault signal		downscale I ≤ 3.6 mA, upscale I ≥ 21 mA (acc. NAMUR NE43)
Collective error message		Power Rail
Transfer characteristics		
Deviation		
Temperature effect		Input: 0.005 %/K (50 ppm) of span ; current output: 0.005 %/K (50 ppm) of span
RTD		max. 0.2 % of span
Thermocouples		max. 10 μV deviation of CJC: ±0.8 K
Voltage		0.1 % of span
Potentiometer		0.1 % of span when < 5 kΩ 0.5 % of span when > 5 kΩ
Current output		max. 20 μA
Sampling rate		approx. 700 ms
Galvanic isolation		
Input/Other circuits		reinforced insulation according to IEC/EN 61010-1, rated insulation voltage 300 V _{eff}
Output I, II against each other		reinforced insulation according to IEC/EN 61010-1, rated insulation voltage 300 V _{eff}
Output I, II/other circuits		reinforced insulation according to IEC/EN 61010-1, rated insulation voltage 300 V _{eff}
Output III/power supply and collective error		reinforced insulation according to IEC/EN 61010-1, rated insulation voltage 300 V _{eff}
Interface/power supply		reinforced insulation according to IEC/EN 61010-1, rated insulation voltage 300 V _{eff}
Indicators/settings		
Display elements		LEDs , display
Control elements		Control panel
Configuration		via operating buttons via PACTware

Release date: 2023-01-03 Date of issue: 2023-01-03 Filename: 231225_eng.pdf

Refer to "General Notes Relating to Pepperl+Fuchs Product Information".

 Pepperl+Fuchs Group
www.pepperl-fuchs.com

 USA: +1 330 486 0002
pa-info@us.pepperl-fuchs.com

 Germany: +49 621 776 2222
pa-info@de.pepperl-fuchs.com

 Singapore: +65 6779 9091
pa-info@sg.pepperl-fuchs.com

 **PEPPERL+FUCHS**

Technical Data

Labeling		space for labeling at the front
Directive conformity		
Electromagnetic compatibility		
Directive 2014/30/EU		EN 61326-1:2013 (industrial locations)
Low voltage		
Directive 2014/35/EU		EN 61010-1:2010
Conformity		
Electromagnetic compatibility		NE 21:2007
Degree of protection		IEC 60529:2001
Ambient conditions		
Ambient temperature		-20 ... 60 °C (-4 ... 140 °F)
Mechanical specifications		
Degree of protection		IP20
Connection		screw terminals
Mass		300 g
Dimensions		40 x 119 x 115 mm (1.6 x 4.7 x 4.5 inch) (W x H x D) , housing type C2
Mounting		on 35 mm DIN mounting rail acc. to EN 60715:2001
Data for application in connection with hazardous areas		
EU-type examination certificate		TÜV 03 ATEX 2140
Marking		⊕ II (1)G [Ex ia Ga] IIC ⊕ II (1)D [Ex ia Da] IIIC ⊕ I (M1) [Ex ia Ma] I
Input		Ex ia
Supply		
Maximum safe voltage	U_m	40 V DC (Attention! The rated voltage can be lower.)
Input		terminals 2, 6 (for active equipment)
Voltage	U_o	13.1 V
Current	I_o	8 mA
Power	P_o	67 mW
Voltage	U_i	29 V
Current	I_i	11 mA
Power	P_i	200 mW
Inputs		terminals 1, 2, 3, 4, 6 (for passive equipment)
Voltage U_o		13.1 V
Current I_o		21 mA
Power P_o		67 mW
Analog output		
Maximum safe voltage	U_m	40 V (Attention! The rated voltage can be lower.)
Interface		
Maximum safe voltage	U_m	40 V (Attention! The rated voltage can be lower.) , RS 232
Certificate		PF 08 CERT 1213 X
Marking		⊕ II 3G Ex nA nC IIC T4 Gc
Output I, II		
Contact loading		50 V AC/2 A/cos $\phi > 0.7$; 40 V DC/1 A resistive load
Galvanic isolation		
Input/Other circuits		safe electrical isolation acc. to IEC/EN 60079-11, voltage peak value 375 V
Directive conformity		
Directive 2014/34/EU		EN IEC 60079-0:2018+AC:2020 , EN 60079-11:2012 , EN 60079-15:2010
International approvals		
IECEx approval		
IECEx certificate		IECEx TUN 09.0019
IECEx marking		[Ex ia Ga] IIC , [Ex ia Da] IIIC , [Ex ia Ma] I
General information		

Release date: 2023-01-03 Date of issue: 2023-01-03 Filename: 231225_eng.pdf

Refer to "General Notes Relating to Pepperl+Fuchs Product Information".

Pepperl+Fuchs Group
www.pepperl-fuchs.comUSA: +1 330 486 0002
pa-info@us.pepperl-fuchs.comGermany: +49 621 776 2222
pa-info@de.pepperl-fuchs.comSingapore: +65 6779 9091
pa-info@sg.pepperl-fuchs.com

PEPPERL+FUCHS

Technical Data







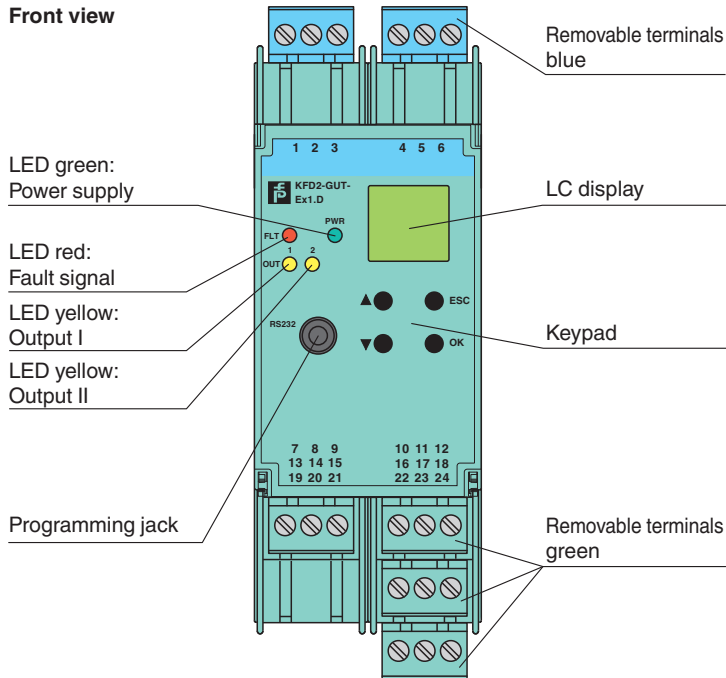

Supplementary information

Observe the certificates, declarations of conformity, instruction manuals, and manuals where applicable. For information see www.pepperl-fuchs.com.

Assembly









Matching System Components

	DTM Interface Technology	Device type manager (DTM) for interface technology
	PACTware 5.0	FDT Framework
	K-ADP-USB	Programming adapter with USB interface
	KFD2-EB2	Power Feed Module
	UPR-03	Universal Power Rail with end caps and cover, 3 conductors, length: 2 m
	UPR-03-M	Universal Power Rail with end caps and cover, 3 conductors, length: 1,6 m
	UPR-03-S	Universal Power Rail with end caps and cover, 3 conductors, length: 0.8 m
	K-DUCT-BU	Profile rail, wiring comb field side, blue
	K-DUCT-BU-UPR-03	Profile rail with UPR-03- * insert, 3 conductors, wiring comb field side, blue

Release date: 2023-01-03 Date of issue: 2023-01-03 Filename: 231225_eng.pdf

Refer to "General Notes Relating to Pepperl+Fuchs Product Information".

Accessories

	K-250R	Measuring resistor
	K-500R0%1	Measuring resistor
	K-CJC-BU	Terminal block for cold junction compensation, 3-pin screw terminal, blue
	KF-ST-5GN	Terminal block for KF modules, 3-pin screw terminal, green
	KF-ST-5BU	Terminal block for KF modules, 3-pin screw terminal, blue
	KF-CP	Red coding pins, packaging unit: 20 x 6

Application

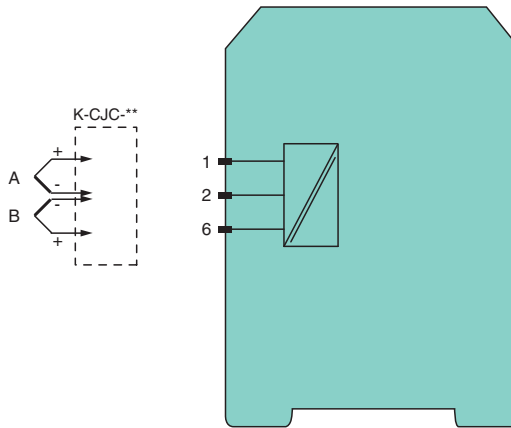

Redundant thermocouple

For higher availability it is possible to connect a second redundant thermocouple (B) of the same type to the temperature converter. The cold junction temperature is taken from the connected terminal block.

If the deviation of the both thermocouples (A and B) exceed the selected tolerance, an error will occur. If a lead breakage of one thermocouple (e. g. A) has been detected, an error message occurs and the value of the second thermocouple (B) will be taken for further calculation.

Release date: 2023-01-03 Date of issue: 2023-01-03 Filename: 231225_eng.pdf

Refer to "General Notes Relating to Pepperl+Fuchs Product Information".