

CR-series SCR Operation Manual

(303W & 304W)

Notice of Safety

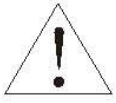

Attention



Danger

- Please connect lines according to National Electrical Code to prevent hazard to human and equipment.
- To prevent electric shock, please make sure that power is turned off before replacing the fuse.
- Please do not use beyond the rated current. If the power is unsteady, please retain sufficient current safety reservation
- Please lock terminal screws tightly to prevent components from being burned due to the surge or overheat of contacts
- The internal parts of the device are components with high voltage and high temperature. Do not touch any terminal to prevent hazard if it is electrified.

APPEARANCE



Model Explanation

CR3- A 2 035 P

Output

- 1: 1 ϕ
- 2: 3 ϕ 2W
- 1 ϕ 2W
- 3: 3 ϕ 3W

Function

- D: Standard
- A: Full function
- Current detection
- V: Full function (developing)
- Voltage detection
- W: Full function (developing)
- Power detector

Voltage spec.

- 2: 220V
- 4: 440V
- (380V)

Current spec.

- 035: 35A
- :
- :
- 450:450A

Control Mode

- P: Phase trigger control
- Z: Zero cross control
- C: 3 ϕ Half-wave
- (Blank): 1 ϕ self-setup

Specifications

Main power	220, 380, 440V \pm 15% 50/60HZ
Control power	200-240VAC (fan included) * 90-240V AC/DC (fans non-included)
Rated current	35A, 50A, 75A, 100A, 125A, 150A, 225A, 300A, 450A
Control mode	Phase trigger control or Zero cross control (only 1 ϕ 1W type)
Control signal Vcmd	0~5V, 1~5V (impedance 20K) 0~10V, 1~10V (impedance 100K) 0~20mA, 4~20mA (impedance 250Ohm)
Output control range	0.0~100.0%
Resolution/Linear	0.1% / 1%
E, ADJ control signal	Analog control: 0~5V (impedance 20K) to 0.0~100.0% on/off control: Hi=3.4V, Lo=2.2V
Serial communication	RS-485 interface, support ModBus protocol in RTU or ASCII format
Cooling Method	natural air circulation or fan cooling
Ambient temperature/humidity	10~+50°C/under 90%RH
Hi pot test	AC2000V/1 min. (between the power, signal terminal & heat sinks)
Noise susceptibility	2KV 5KHZ
Isolation resistor	over 20M Ω /500V (between the power, signal terminal & heat sinks)
Housing Material	ABS (UL94V)

Optional information:

1. If the optional model is with full function (A,V,W) and the control mode is with phase control, the controller can be planned as a constant current (or constant voltage - constant power) control mode. Please refer to the parameter settings
2. The full function model is included the serial communication (RS-485) which can support ModBus protocol in RTU or ASCII format. Please refer to the communication spec. (Standard type is not included RS-485 and it's only for display.)
3. Current has a wide range of specifications. Please refer to the product specifications
4. CRx-xxxxP can be planned to phase / zero control.
5. 3 ϕ phase control [control mode] with P-type and C-type two options.
P-type (standard):
Using 6sets SCR to control each phase +/- phase voltage. This is called "3 ϕ full-wave controlled". Its characteristics is to control the output line current without DC component (average = 0). It's suitable for inductive (or resistive) load. Such as motors, transformers and so on. The controllable phase angle only have 0~150 degrees control range.
C-type
Using 3sets SCR & 3sets diodes to control each phase half-circumference phase voltage This's called "3 ϕ half-wave controlled". It has a wide phase angle control range (0~120 degree). It's suitable for micro voltage adjustment. Due to line current has DC component, therefore, it's only suitable for resistive load.
5. Current calculation and specifications used
(3 ϕ) I(AMP) = P(watt) : V(voltage) : $\sqrt{3}$: 0.85 (15% safety reservation)
(1 ϕ) I(AMP) = P(watt) : V(voltage) : $\sqrt{3}$: 0.85 (15% safety reservation)

Fuse Spec.

Pls use the available fuses, the below is model# for Bussmann & (P)

Current	Fuse model# 240V(P)/415V(P)	Current	Fuse model# 240V(P)/415V(P)	Current	Fuse model# 240V(P)/415V(P)	Current	Fuse model# 240V(P)/415V(P)
35A	50LET(1400)/50FE(380)	100A	125LET(7500)/ NIDEC660GH125(10600)	180A	200LMT(20000)/200FM(10500)	380A	-----/Nidec 660GH400(112000)
50A	63LET(2200)/63FE(480)	125A	160LET(16000)/ NIDEC660GH125(10600)	225A	250LMT(40000)/280FM(10500)	450A	-----/280FM(30500)2pcs
75A	80LET(3800)/100FE(1800)	150A	180LET(29000)/ NIDEC660GH125*2PCS	300A	355LMT(100000)/350FM(60000)		

Input/Output setting

Make sure the control signals based on the input type and then adjust by the below table accordingly to avoid control errors.

■ : ON □ : OFF ☒ : Don't Care

Input signal	S4	S3	S2	S1	Input signal	S4	S3	S2	S1
0~5V	<input type="checkbox"/>	<input type="checkbox"/>	<input checked="" type="checkbox"/>	<input checked="" type="checkbox"/>	2~10V	<input type="checkbox"/>	<input checked="" type="checkbox"/>	<input type="checkbox"/>	<input checked="" type="checkbox"/>
1~5V	<input type="checkbox"/>	<input type="checkbox"/>	<input type="checkbox"/>	<input checked="" type="checkbox"/>	0~20mA	<input checked="" type="checkbox"/>	<input type="checkbox"/>	<input checked="" type="checkbox"/>	<input checked="" type="checkbox"/>
0~10V	<input type="checkbox"/>	<input checked="" type="checkbox"/>	<input checked="" type="checkbox"/>	<input checked="" type="checkbox"/>	4~20mA	<input checked="" type="checkbox"/>	<input type="checkbox"/>	<input type="checkbox"/>	<input checked="" type="checkbox"/>

CRx-xxxxP phase/zero cross control settings
Note: Change control mode must be rebooted

Output Control	S4	S3	S2	S1
Phase trigger control	<input checked="" type="checkbox"/>	<input checked="" type="checkbox"/>	<input checked="" type="checkbox"/>	<input checked="" type="checkbox"/>
Zero cross trigger control	<input checked="" type="checkbox"/>	<input checked="" type="checkbox"/>	<input checked="" type="checkbox"/>	<input type="checkbox"/>

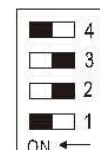

DIP switches SW11 on the main control panel

Phase / zero control output waveform

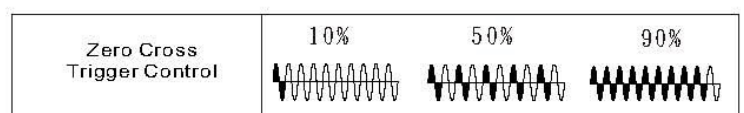
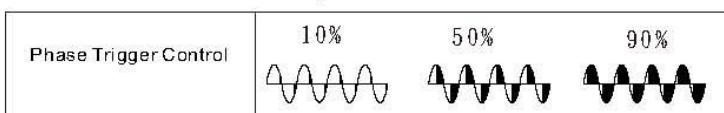

Parameter setting / operating

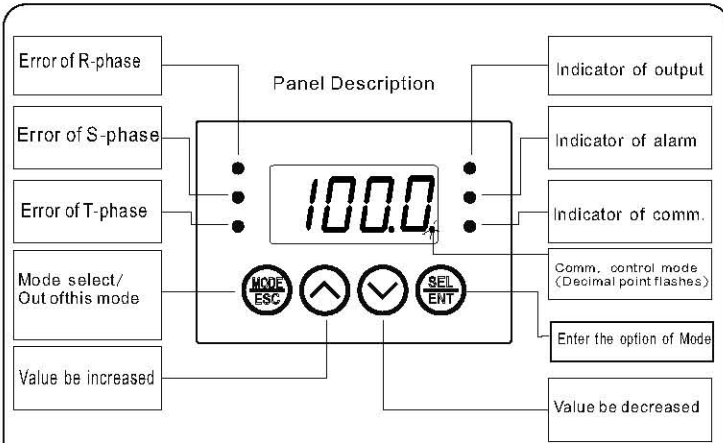

Key operation:
 Press [MODE] key to start the parameter setting, and then [SET] to call out the parameters, using the up / down key to change the parameter value. To press [SET] button for 1 second to write the parameters into the memory. To cancel the change of the parameters, press the [MODE] key to exit before written by pressing the [SET] key. Press and hold the [MODE] key for 3 seconds or don't press any key more than 120 seconds to end the set-up function of parameters to return to the display mode.

[Step 1] Parameter, press [MODE] to start		
Display	Description	Default Value
dISP	disp: when select the normal condition, what types of value will be displayed PErE → uCnd → HEAtE → I r → I S pert: output percentage Vcmd: control signal Heat: heat sink temperature Ir: R (1 φ) phase current IS: S phase current I E → I A T-phase current average current	PErE
STUP	stup: 1st time to start or standby over 5 minutes, soft start time (See [control signal modulation]) Range: 1~100 secs.	10Sec.
rESP	resp: control signal (Vcmd, Ccmd) response time (See [control signal modulation]) range: 1~60 seconds	2Sec.
[Step 2] Press the [MODE] key for 3 seconds to start		
Display	Description	Default Value
HLtd	Hltd: maxi. output limit setting (constant current mode, maxi. output current). range: 50~100%	100%
LLtd	LLtd: Vcmd=0 (see Vcut parameter), mini. output limit setting (constant current mode, mini. output current). range: 0~50%	0%
ALtr	Altr: alarm output delay time when Abnormal. range: 0~20 seconds	1Sec
Cool	Cool: Fan start temperature. range: 5~60°C	50°
ERAdj	Eadj: Select external control to control Vcmd nULL → nUL → Add → Sub null: no effect MUL: Vcmd x Eadj Add: Vcmd+Eadj Sub: Vcmd - Eadj Avg: (Vcmd+Eadj)/2 Strt: On/Off control	nULL
uCuE	Vcut: when Vcmd (Ccmd)=0, select LltD output or close output. StOP → LLtd Stop: close output LltD: output by mini. of output value	StOP
HCur	Hcur: (optional) high current. when current value bigger than set value, error occurred. see [F HC] parameter. (phase: above 30%, zero cross 50% above start detect. set 0 as close function) range: 0~500A	0A
LCur	Lcur: (optional) low current. when current value lower set value, error occurred. see [F LC] parameter. (phase: above 30%, zero cross 50% above start detect. set 0 as close function) range: 0~500A	0A
bALn	bALn: (optional) 3 φ current no-balance setting. when 3 φ current is unbalance, the value between maxi. current & mini. current bigger than set value, error occurred. see [F bL] parameter. (phase: above 30%, zero cross 50% start detect. set 0 as close function) range: 0~500A	0A
tP	Kp: (optional) constant current (voltage/power) control deviation magnification settings. the greater the value the more sensitive response. range: 10~100%	100%
PLtd	Pltd: (optional) constant current control, limit the maximum phase angle. inductive load due to voltage phase is ahead current phase, this feature can prevent failure of SCR trigger. range: 50~100%	100%

[Step 3] Press [MODE]+[UP] key for 3 seconds to start		
Display	Description	Default Value
uCnd	Vcmd: setup Vcmd display value to response the control signal. See [inout/output setting]	4-20
u r E	Wire: set up CR3-xxxP wiring method 3P3L: 3 Phase 3 Line 3P4L: 3 Phase 4 Line	3P3L
nA in	Main: Main power anomaly occurs disposal. 3 options. nULL → ALAn → StOP null: ignore this anomaly ALAM: alarm output, keep working Stop: alarm output, shutdown the machine	StOP
FUSE	Fuse: The fuse blown anomaly occurred disposal. option is same.	StOP
F Ld	F Ld: (LOAD) disconnection occurred disposal. option is same as above. standard type under 75A (non-included) has not this feature, please must set as NULL...	ALAn
SEnS	SENS: temperature switch failure occurred disposal. option is same as above. when output 10 minutes continuously, temperature value is still on 0 degree C.	ALAn
F HC	F HC: high current anomaly occurred disposal. option is same as above.	ALAn
F LC	F LC: low current anomaly occurred disposal. option is same as above.	ALAn
F bL	F bL: 3 phase unbalance anomaly disposal. option is same as above.	ALAn
F SCR	F SCR: SCR breakdown anomaly occurred disposal. option is same as above.	StOP
Ctrl	Ctrl: (optional) control options, phase/constant current/ constant voltage/constant power controlled PHAS → iOUT → uOUT → PoUT Phas: phase control iout: constant current uout: constant voltage Pout: constant power	PHAS
id	id: (optional) communication station setting range: 1~99	1
baUD	baud: (optional) communication speed range: 2.4, 4.8, 9.6, 19.2, 38.4, kbit/sec	9.6
data	data: (optional) communications serial format. range: 8n1, 8n2, 8e1, 8o1.	8n1
node	mode: (optional) ModBus communications format range: RTU, ASCII.	RTU
toUt	tout: (optional) communication timeout setting. when the communication disconnection time exceeds, then the remove communication output control will transfer to the vcmd to control. range: 2~99S	5Sec.
[Other]		
LoCt	Press [MODE]+[DOWN] key for 3 seconds to start Lock: parameter protection setting. range: 0~3 0: all cannot setup 1: open step 1, 2: open step 1, 2, 3: all open	3
tEST	Press [SET] key for 3 seconds to start test: manual output testing. range: 0~100%	0%

Anomaly display (press [SET]+[UP] key to clear)

Display	Description	Comm. code
oC	OC: (optional) over-current, when the current value exceeds rated value more than 1.2 times, the controller will stop output. please check the load whether short-circuit.	1
nA in	Main: the main power anomaly. check the input switch or the controller fuse if it is normal.	2
HCur	Hcur: (optional) high current	3
Sint	Sink: heat sink temperature exceeds 80 degrees, the controller will stop output. check the fan spins and environmental ventilation.	4
FUSE	Fuse: fuse breakdown. please confirm fuse spec. & load power or if the connection screws has locked tight (heat fuse)	5
LoAd	Load: Load Break	6
LCur	LCur: (optional) low current.	7
tHER	Ther: temperature sensor anomaly. check the pin plug of temperature sensor whether is bad connection, (impedance is about 3K ~ 10K ohm)	8
SCR	SCR: (optional) SCR breakdown. please return for repairing.	9
UnbL	Unbl: (optional) 3 phase unbalance	10

Modulation for control signals

- The relations between mini./maxi. output and Vcmd (Ccmd)
Remarks: Ccmd is the communication signal. See [comm. control]

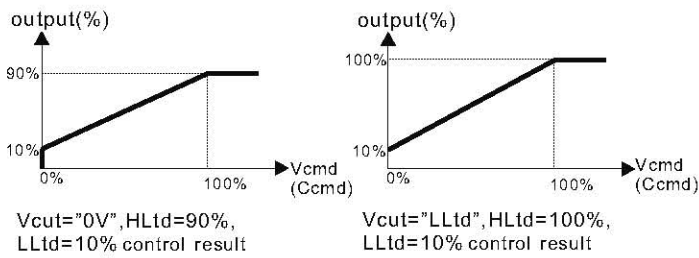

- Soft start time (STUP), the relations between response time (RESP) & output

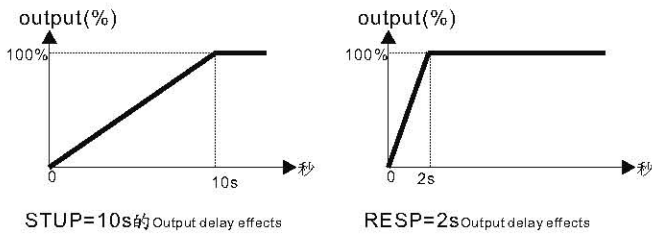

(power on or standby over 5 minutes)

Constant current/voltage/power (optional functions)

If parameter "CTRL" setup as IOUT current control/vOUT voltage control or pOUT power control (below is the current example), the controller will enter the constant current control mode and Vcmd (Ccmd) will also convert to current target value (SV) automatically. Parameter Kp limited the maxi. current value.

Ex: model #CR3-A4075P (440V/75A), when Vcmd = 100%
Kp = 30%, current target value = 75A x 30% = 22.5A
Kp = 50%, current target value = 75A x 50% = 37.5A
Kp = 100%, current target value = 75A x 100% = 75A

The controller adopted a proportional - integral (PI) as a constant current control operation. Parameters "Kp" is for the proportional gain, the greater output response sensitive the more value setting, please see the load characteristics adjusted to the best value.

Below is the diagram shows:

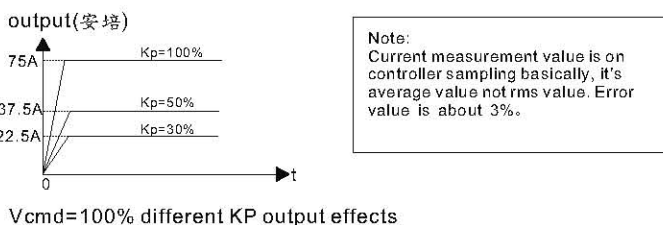

Comm. control output Ccmd (optional function)

The controller can use the communication to control the SCR output value to replace Vcmd.

- Method:
- Set the contacts (coil) IP0x01 to 1 (comm. control).
The first decimal point on the display start flashes.

- Change the register (reg. Ip4x016) value, SCR output immediate change.

Note:
Under the communication control mode, even if no change the output, which must keep the communicate status with the controller, for example, keep reading the register or contacts address value. Otherwise, the controller will determine the communication disconnection. If the disconnection time longer than Tout, the controller will automatically remove the communication control function to avoid danger.

Description for communication address

Explanation	Modbus address	Data length	R/W
Unexpected condition cleared 1: Lift the unusual alarm (Automatic recovery to 0)	00001	bit	R/W
Select control mode 1: communication 0: external	00002	bit	R/W
Output mode 1: start 0: stop	00003	bit	R
Fan spinning mode 1: start 0: stop	00004	bit	R

Explanation	Modbus Address	Data Length	R/W
R-phase Abnormal signal 1: on 0: off	00005	bit	R
S-phase Abnormal signal 1: on 0: off	00006	bit	R
T-phase Abnormal signal 1: on 0: off	00007	bit	R
Over current (OC) abnormal status 1: Abnormal 0: normal	00008	bit	R
Over temperature (SINK) abnormal status 1: Abnormal 0: normal	00009	bit	R
High current (HCUR) abnormal status 1: Abnormal 0: normal	00010	bit	R
Low current (LCUR) abnormal status 1: Abnormal 0: normal	00011	bit	R
3 phase unbalance (UNBL) abnormal status 1: Abnormal 0: normal	00012	bit	R
Main power (MAIN) abnormal status 1: Abnormal 0: normal	00013	bit	R
Fuse (FUSE) abnormal status 1: Abnormal 0: normal	00014	bit	R
Load (LOAD) abnormal status 1: Abnormal 0: normal	00015	bit	R
SCR (SCR) abnormal status 1: Abnormal 0: normal	00016	bit	R
Soft start time (STUP) Range: 1~99 second	40001	word	R/W
Response speed time (RESP) Range: 1~30 second	40002	word	R/W
Maximum of output value (HLtd) Range: 50~100%	40003	word	R/W
Manimum of output value (LLtd) Range: 0~50%	40004	word	R/W
High current setting (HC) Range: 0~600A	40005	word	R/W
Low current setting (LC) Range: 0~600A	40006	word	R/W
3 phase unbalance current setting (BALN) Range: 0~600A	40007	word	R/W
Proportional gain value setting (Kp) Range: 10~100%	40008	word	R/W
the maximum phase angle limited setting (PLTD) Range: 50~100%	40009	word	R/W
Alarm output delay time setting (ALTR) Range: 0~20 second	40010	word	R/W
Fan start temperature setting (COOL) Range: 5~60 degree	40011	word	R/W
Communication control signal (Ccmd) Range: 0~1000 (unit 0.1%)	40016	word	R/W
Analog control signal (Vcmd) Range: 0~input spec. (unit 0.1 mA or V)	40017	word	R
SCR present output Range: 0~1000 (unit: 0.1%)	40018	word	R
Heat sink temperature Range: 0~100 degree C	40019	word	R
R-phase current Range: 0~see spec. (unit: 0.1A)	40020	word	R
S-phase current Range: 0~see spec. (unit: 0.1A)	40021	word	R
T-phase current Range: 0~see spec. (unit: 0.1A)	40022	word	R
3 phase average current Range: 0~see spec. (unit: 0.1A)	40023	word	R
Output voltage Range: 0~see spec. (unit: 0.1V)	40024	word	R
Output power Range: 0~see spec. (unit: 0.1kW)	40025	word	R
Unexpected condition Unusual code: 0~10 (0: usual) 1: Over current (OC) 2: Main power (MAIN) 3: High current (HC) 4: Over heat (SINK) 5: Fuse (FUSE) 6: Overload break (LOAD) 7: Low curreNt (LO) 8: Sensor (SENS) 9: SCR short circuit (SCR) 10: 3 phase non-balance (UNBL)	40026	word	R
Contacts (coil) Status string pattern LSB(0x01)~MSB(0x16) accordingly	40027	word	R

Communication can support RTF or ASCII format, allows up to continuously 8 data for reading/writing, the above address is 10 hex.

Read and write please refer to the ModBus protocol. .

Dimension

Type	Current	Length L(mm)	Width W(mm)	Height H(mm)	A & B(mm)	Cooling Way	P
Cr1 1φ1W	75A	203	120	153	215,80	Nature cooling	3
	100A 125A 150A	228	120	153	215,80	Fan cooling	3
	180A 225A	306	120	220	280,80		5
	300A 380A	306	120	220	280,80		5
Cr2 3φ2W	35A	203	120	153	215,80	Nature cooling	3
	50A 75A	228	120	153	215,80	Fan cooling	3
	100A 125A 150A	241	120	220	215,80		4
	180A 225A	306	120	220	280,80		5
	300A 380A	310	245	220	295,160		
	Cr3 3φ3W	35A	203	120	153	215,80	Nature cooling
50A		228	120	153	215,80	Fan cooling	3
75A 100A		241	120	220	215,80		4
125A 150A		306	120	220	280,80		5
180A 225A		310	245	220	295,160		
300A 380A		395	245	220	380,160		
450A		395	365	220	380,280		

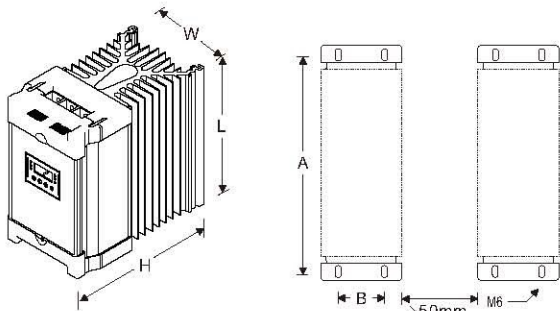

Installation instruction

- Adopts vertical installing so as to achieve the best radiation effect
- Notice the width of the interspace between two heat sinks to ensure the best radiation ability (>50mm)
- Keep the sufficient space for ventilation at the upper and lower side (>50mm)
- Control cabinet should have vent holes and mounted with fans so as to make ventilation better
- If the internal temperature is too high, please use the current lower than 70% of rated current

Wiring diagram

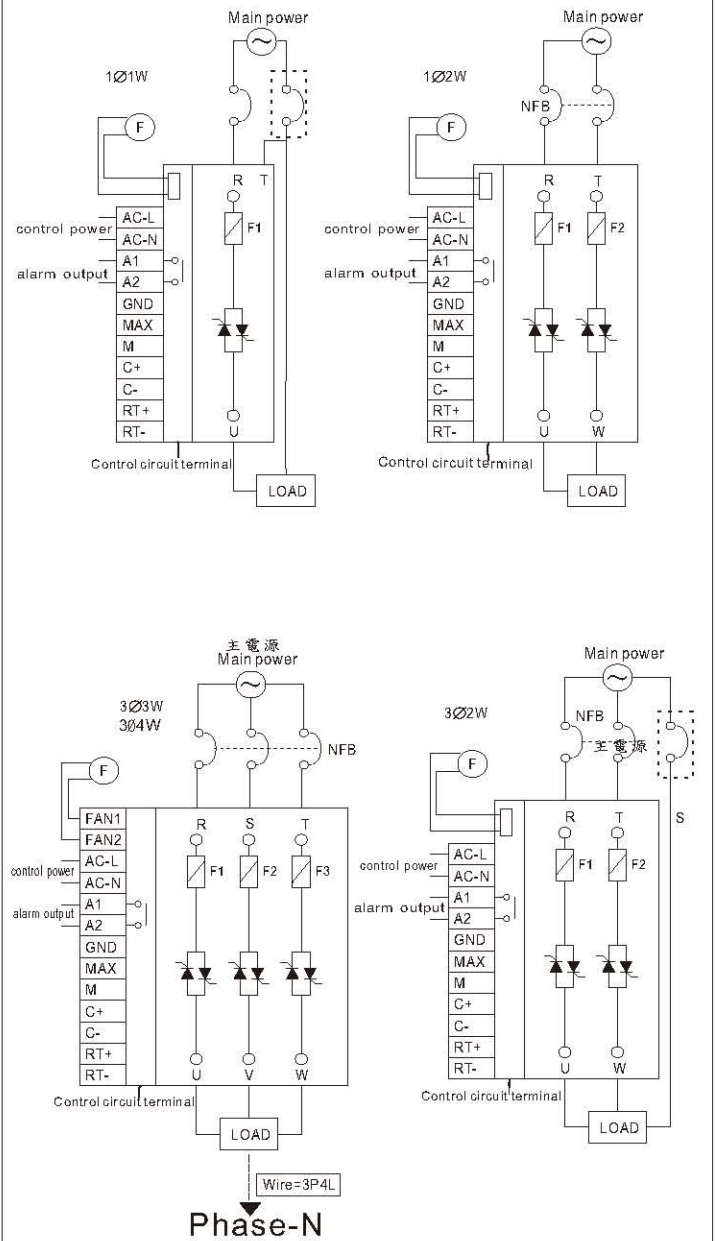

Input signal wiring diagram

Control signal (Vcmd)

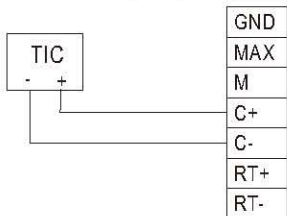

Manual adjustment

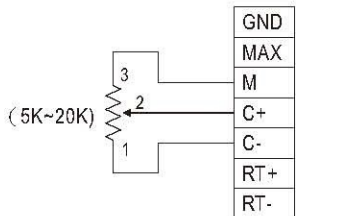

Communication control

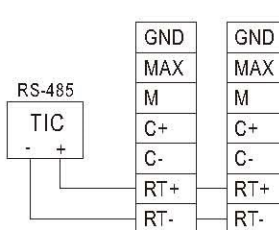

Muti-unit link in control

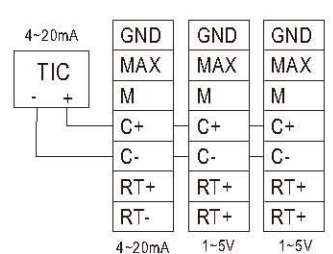

Auto/Manual external switch

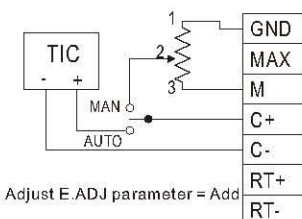

Control signal external adjustment

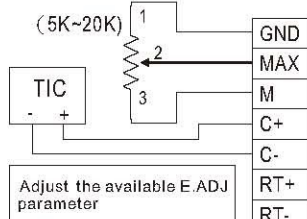

Start/stop control

