

Serie Protection

SR660

Nylon Protection Cable Chain with openable covers

Inner height (D) 36 mm
 Double share Sideband & Frame construction with large anti-friction single-pin. Covers are openable from inner radius.
 Vertical separators are available.

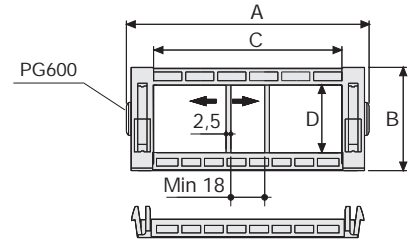
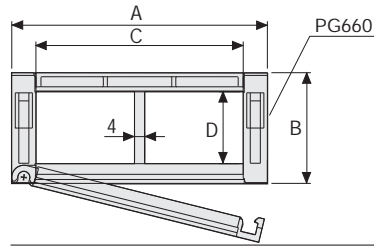

Separator	
- Unassembled	Part.no S660
- Assembled	Part.no S660MC

Separator	
- Unassembled	Part.no S600
- Assembled	Part.no S600MC

Technical characteristics when self-supported

Speed	6 m/s
Acceleration	30 m/s ²

For higher requirements please consult our technical dept.

A	B	C	D	R	Weight/m	Chain
mm	mm	mm	mm	mm	kg	Part Number
79	55	50	36	100-150-200-250	1,90	SR660050□□□*
129	55	100	36	100-150-200-250	2,40	SR660100□□□*
179	55	150	36	100-150-200-250	3,00	SR60015□□**

*Complete the code by inserting the value of the radius (R): Ex. SR660050 □ □ □ □

**Complete the code by inserting the value of the radius (R): Ex. SR60015 □ □

Where: 0=100; 1=150; 2=200; 3=250

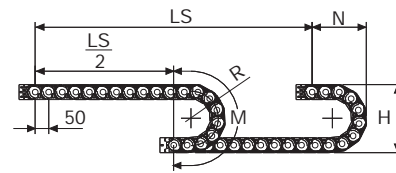

R	H	N	M
mm	mm	mm	mm
100	255	180	415
150	355	230	575
200	455	280	730
250	555	330	885

Length of chain (L)
 Half travel distance ($\frac{LS}{2}$)
 plus length of curve (M)

$$L = \frac{LS}{2} + M$$



Self-Supporting Capacity Diagram

The maximum length of the self-supporting capacity ($\frac{LS}{2}$) in relationship to the weight of the cables and hoses contained per linear metre.

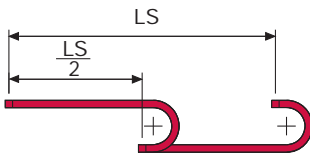
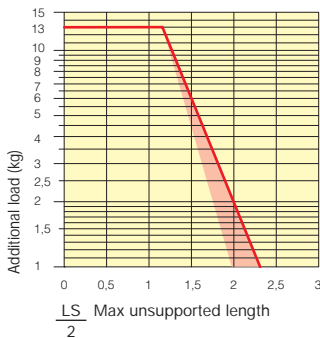

The red marking in the diagram area considers the difference of weight between various widths of chain.

For applications with $\frac{LS}{2}$ and weights not included in the area of the diagram showing self-supporting capacity, verify the possible use of support rollers (see page 30).

End Brackets

The end brackets set allows the two ends of the chain to be attached to the equipment.

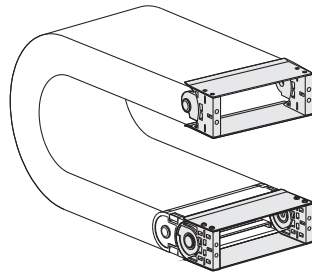
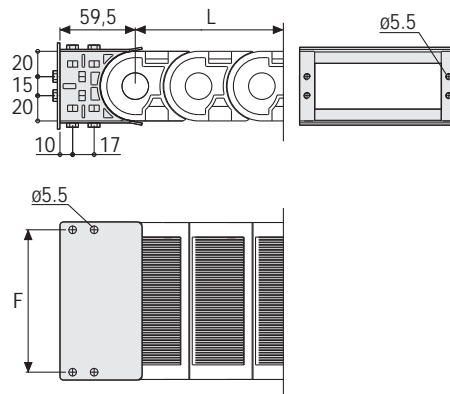

Fig. A
The chain can be fixed frontally, inner or outer radius. (Fig A)



Chain Type	F mm
SR660 C=50	62
SR660 C=100	112
SR600 C=150	162

Nylon Type Part Numbers

Complete Set Assembled	
Chain Type	End Brackets Set
SR660 C=50	AN660050KM
SR660 C=100	AN660100KM
SR600 C=150	AL600KM

Complete Set Unassembled	
Chain Type	End Brackets Set
SR660 C=50	AN660050K
SR660 C=100	AN660100K
SR600 C=150	AL600K

Serie Protection

SR660

Nylon Protection Cable Chain with openable covers

3

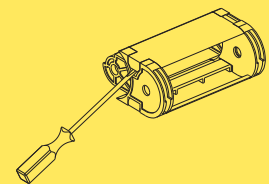
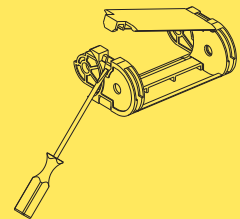

How to open the cover.

Special tool to remove the connecting pivots:
Part Number PZ010.



For further information please consult Brevetti Stendalto's Technical Office