



Product overview

Balancing systems

Sensors

Electronics

Condition Monitoring

**Keeping our ear
to your process**

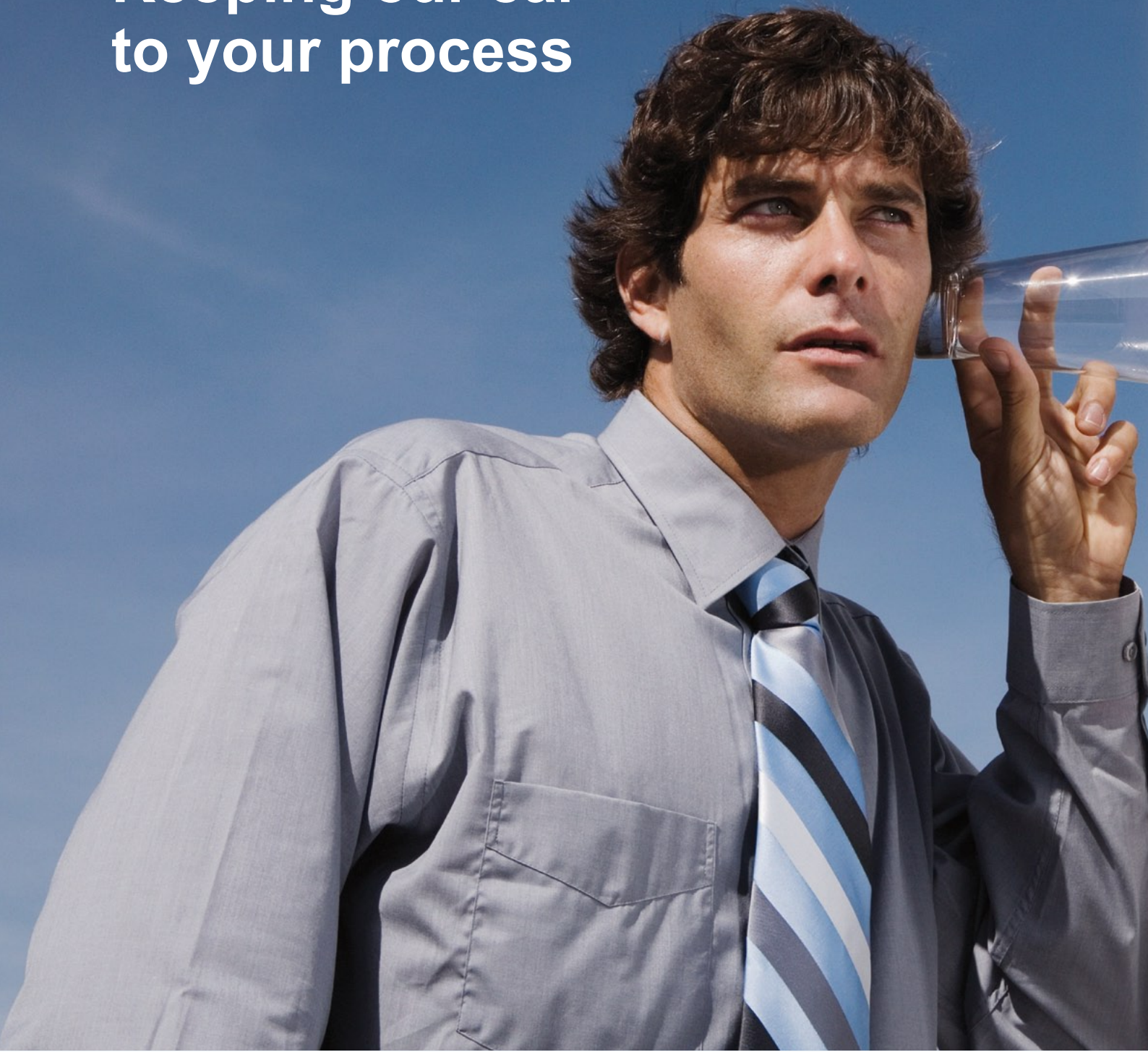

Using DITTEL systems and components for monitoring and controlling grinding applications and dressing processes the efficiency and safety of your grinding and combi machines will increase.

The DITTEL systems are suitable for surface grinding, cylindrical surface grinding, internal circular grinding, gear grinding or tool grinding machines – whether grinding steel, ceramic or glass workpieces. Monitoring processes are essential when using CBN and diamond grinding wheels.

When DITTEL was founded in 1959, it was involved with the development and series production of avionics. The company is now active in the fields of measuring technologies, airborne transceivers and power electronics.

We provide our customers with individual advice in order to make their businesses more successful, covering topics from planning to training.

We also pick up trends in our customers' markets and, in turn, develop new products in close co-operation with our customers. And ultimately, our network of highly effective alliances, industrial partners, university and research facilities, working groups and industrial associations, all serve to benefit you, the customer.

Twelve agencies around the world are present to respond to the demand of our customers.

Since the beginning DITTEL stands for precision, quality and reliability.

Electromechanical balancing

DITTEL balancing systems are based on a highly precise mechanical balancing head and a well-established balancing strategy. The use of DITTEL balancing systems ensure that imbalances are detected early and dealt with in time. This in turn provides our customers with a constantly high level of workpiece quality and long machine and tool life.

The mechanical balancing system for the detection, counter-balancing and compensation of imbalances consists of a balancing head, a highly precise acceleration pick-up, a revolution counter and the M6000 electronic module from the DS6000 (Dittel System 6000). Depending on the design of the balancing head it is possible to integrate an Acoustic Emission sensor (see table). So the extension of the system by an Acoustic Emission Module AE6000 due to modular design is easily made. This further optimizes the overall performance.

DITTEL offers:

- External balancing heads
- Built-in balancing heads
- 2-plane balancing heads
- Hydro-balancing systems (also page 6)



Built-in balancing heads:

Applications:

For all grinding machines with a frontal spindleboring

Advantages:

- Balancing head in the centre of imbalance
- RPMs up to 20,000 1/min
- Minimum interference
- No maintenance
- AE sensor can be integrated
- Non-contact power transmission

DITTEL's electromechanical balancing heads can be mounted either in or, using customer designed flanges, on the end of the grinding spindle. The balancing heads are compact, cover a wide range of balancing capacities and are suitable for high RPMs. Signals and power are transmitted without physical contact, eliminating the need for virtually all system maintenance.

Acoustic emission sensors can be integrated into the balancing head, significantly increasing the range of functions - and the benefits to the customer.



External balancing heads:

Applications:

For all grinding machines without automatic quick change

Advantages:

- Suitable for retrofitting
- RPMs up to 10,000 1/min
- Easy to assemble
- Compact design
- No maintenance
- AE sensor can be integrated
- Non-contact power transmission
- Alternatively with attached transmitter



2-plane balancing heads:

Applications:

For all grinding machines with frontal spindleboring

Advantages:

- 2-plane balancing head in the centre of imbalance
- RPMs up to 10,000 1/min
- particularly suited to wide grinding wheels or 2 wheels on one spindle
- Compact design
- No maintenance
- AE sensor can be integrated
- Non-contact power transmission

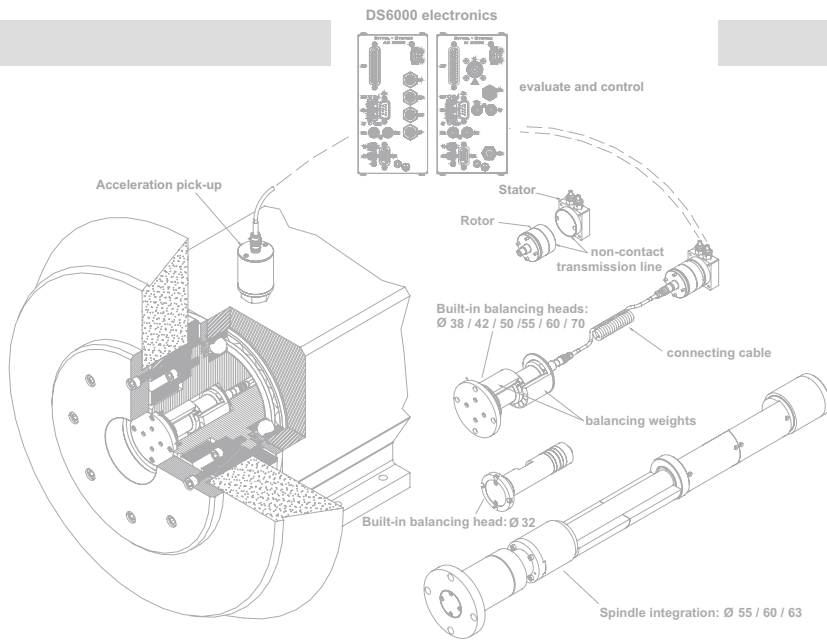

Model of a 2-plane balancing system with two acceleration pick-ups, DS6000 modules and PC6000 Remote control

Types	Outer Ø [mm]	Install. Length without flange [mm]	Capacity max. [cmg]	Max. rev., [min -1]	AE sensor possible	Neutral position possible	
External	80	77	800	10.000	■	■	
	102	77	2.500	5.500	■	■	
	122	77	5.000	4.000	■	■	
External with attached transmitter	80	120	800	8.000	■	■	
	102	120	2.500	5.500	■	■	
	122	120	5.000	4.000	■	■	
Built in	38 f7	115	180	20.000	■	■	
		115	200	20.000	■	■	
		135	400	16.000	■	■	
	42 f7	115	500	15.000	■	■	
		135	640	13.500	■	■	
		225	1.000	10.500	■	■	
	50 f7	115	1.100	10.000	■	■	
		135	1.300	9.500	■	■	
		225	2.200	8.000	■	■	
		225	2.200	8.000	■	■	
	55 f7	115	1.500	8.500	■	■	
		225	3.000	6.500	■	■	
60 f7	115	2.000	7.500	■	■		
	224	4.200	3.000	■	■		
70 f7	115	3.300	6.000	■	■		
70/71 f7	224	7.000	3.300	■	■		
80/81 f7	224	8.000	2.000	■	■		
Built in torque free	28 f7	95	50	20.000	■	■	
		110	50	20.000	■	■	
	32 f7	115	105	19.000	■	■	
		135	135	18.500	■	■	
	38 f7	115	140	11.500	■	■	
	42 f7	115	180	10.500	■	■	
	50 f7	115	320	10.000	■	■	
115		440	10.000	■	■		
Built in long	55 f7	350	2.000	4.000	■	■	
		410	3.000	4.000	■	■	
		470	4.000	4.000	■	■	
	60 f7	350	2.500	4.000	■	■	
		410	3.800	3.500	■	■	
		470	5.000	3.500	■	■	
	63 f7	350	3.100	4.000	■	■	
		410	4.600	3.500	■	■	
		470	6.000	3.500	■	■	
	Built in long torque free	60 f7	410	900	4.500	■	■
			410	3.200	3.000	■	■

Upper capacity on requirey

Hydro-balancing

The hydro-balancing system can be used on any grinding machine. The imbalance is compensated for by injecting coolant or oil in 3 or 4 balancing chambers, which are integrated into a balancing container or directly into the grinding wheel flange.

The balancing container can be delivered in various designs depending on the specifications of customers' machines. This makes it very easy to retrofit the system on older machines which did not have any integrated automatic balancing system till now.

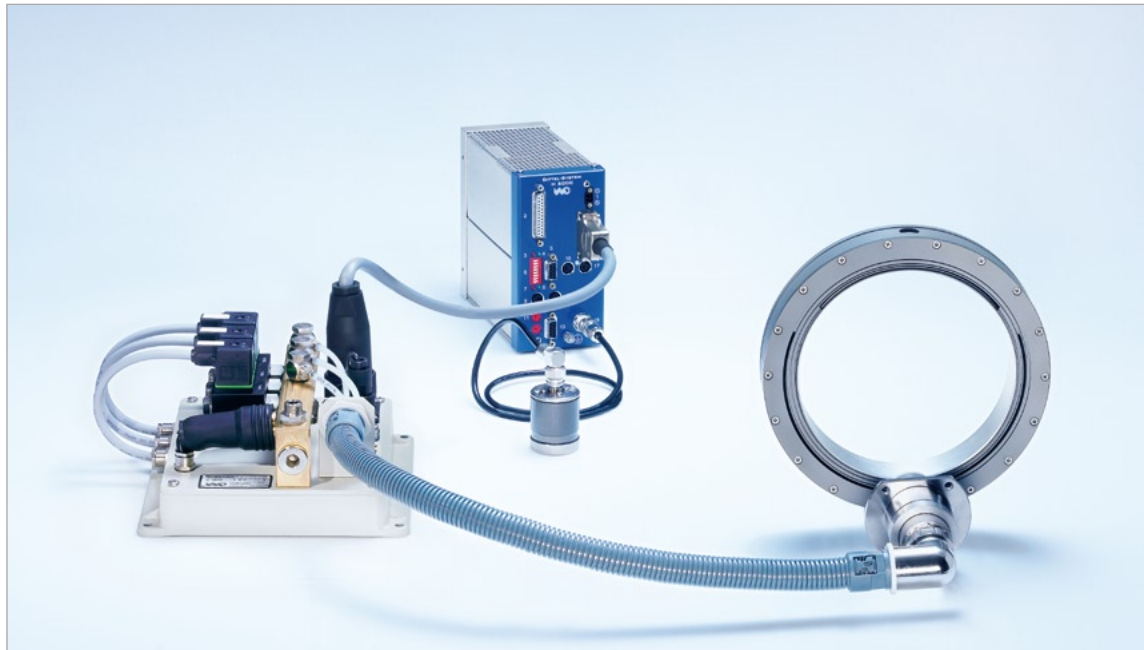

Installation options:

- Balancing container mounted before grinding wheel, nozzle unit mounted in protective cover
- Balancing container mounted behind the grinding wheel, nozzle unit mounted on spindle housing
- Balancing chambers integrated into grinding wheel flange, nozzle unit mounted on wheel housing or protective cover

Applications:

- For all grinding machines with automatic grinding wheel change
- For spindles where a centrally balancing head cannot be mounted

Advantages:

- Easy to retrofit
- Flexible design
- RPMs up to 30,000 1/min

Acoustic Emission (AE)

When removing material from workpiece (e.g. during grinding), a noise acoustic emission is generated in the machine elements that are involved in the process – an emission that consists of measurable frequencies mainly in the ultrasonic range. These frequencies are detected by DITTEL's AE sensors and rapidly analyzed, assessed and visualized by the diagnosis and monitoring systems to determine the current state of workpiece quality, tool wear and the machine itself. Whether a machine breaks down or stays in operation depends to a great extent on knowing about the faults that can arise. The sensors used by the system must therefore meet very high standards. DITTEL offers a wide variety of highly sensitive static or rotating AE sensors (with non-contact signal transmission) that can detect even the slightest signal deviation, enabling you to tap into the full production technology potential of your machine tools and to systematically reduce process costs. The outstanding signal-to-noise ratio of DITTEL's AE sensors ensures that your processes are as stable as possible.

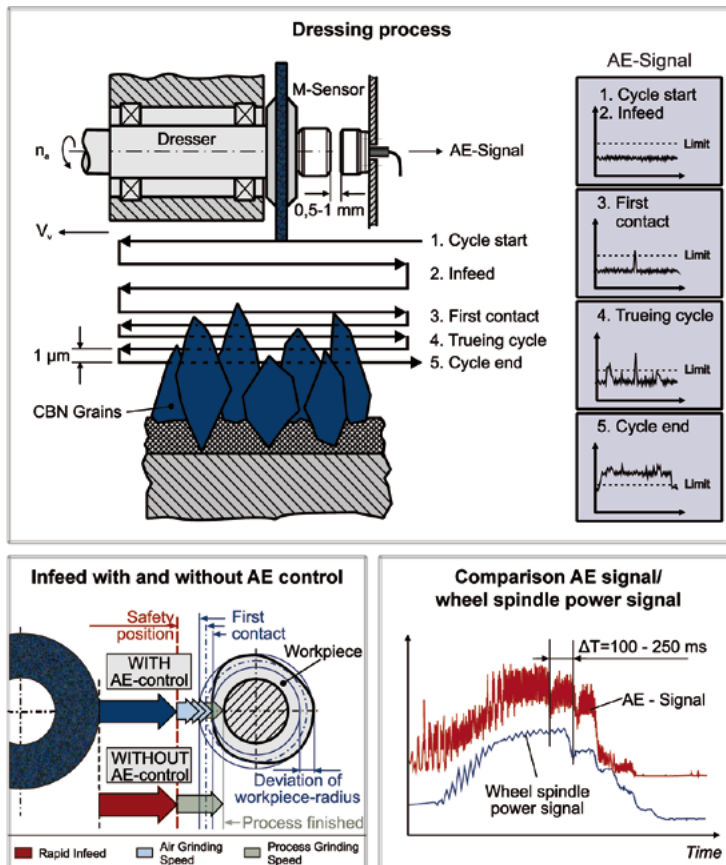

Potential uses

Collision monitoring (Crash Control)

Tool collision is detected as quickly as possible, helping to avoid or minimize further damage to the machine.

First detection

By evaluating the AE signal, it is possible to detect the tool or workpiece first contact position to the micrometer, thus reducing non-productive “air grinding” time.

Process visualization

When the process is visualized on the display, the process technologists are in a position to make conclusions about the course of the process, to observe it and carry out process and error analyses.

Process optimization

Via powerful software and analyze tools you can optimize your processes and minimize processing time while maintaining the same level of quality.

Acoustic Emission:

The cutting process also generates vibrations at the point of contact between the tool and the workpiece. These vibrations manifest themselves as sound. The sound waves consist of and transport kinetic energy that changes the stress in the material and, in turn, leads to short-term plastic deformations, shifting and displacements in the nanometer range. The dynamic displacements generate high-frequency vibrations known as acoustic emissions (AE) that can be detected beyond the point of direct contact between tool and workpiece with the aid of the piezo effect, and are measured as changes in electrical potential.

The acoustic emissions (also known as structural noise, depending on the medium in which they are disseminated) are inaudible, ultrasound signals. The electrical signals measured in this way consist of characteristic frequencies and sound amplitudes that are specific to the cutting operations and can therefore be used to monitor the process.

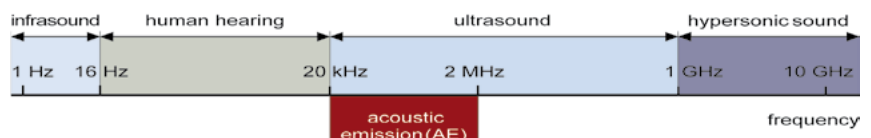

Sensors

Static sensors

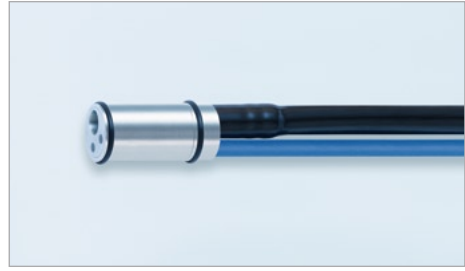
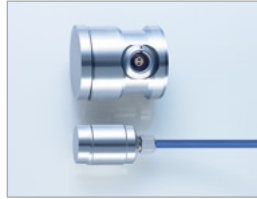
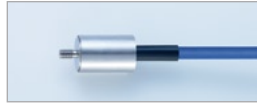

Types:

- S sensor
- Mini-S sensor
- SF sensor
- Magnetic sensor
- Mini magnetic sensor
- Micro-S sensor

Applications for example:

Stationary dressing tools:

- Single point diamond
- Blade type diamond

Appropriate sensor position:

- On the workpiece headstock
- On the tailstock
- On the machine's headstock

Additional functions:

- Monitoring of dressing and grinding processes

Customer benefits:

- Easy to assemble
- High signal quality

AE fluid sensor:

DITTEL's newly developed AE fluid sensor is the latest addition to the company's range of AE sensors for grinding process optimization. The acoustic emission is transmitted in the opposite direction to the flow of liquid from the machine's coolant system (either grinding oil or cooling emulsion). By electrically and acoustically isolating the AE fluid sensor from the machine tool, DITTEL has managed to suppress the machine's background noise.

Brief description:

Dressing and process monitoring while grinding rotating and static surfaces.

Signal transmission:

- From the workpiece
- From the tool
- From the workpiece headstock
- From the workpiece holder

Customer benefits:

- Easy to assemble
- Suitable for retrofitting
- Unsusceptible to the electromagnetic interference generated by the machine itself
- Connects all DITTEL AE evaluation systems without additional preamplifier

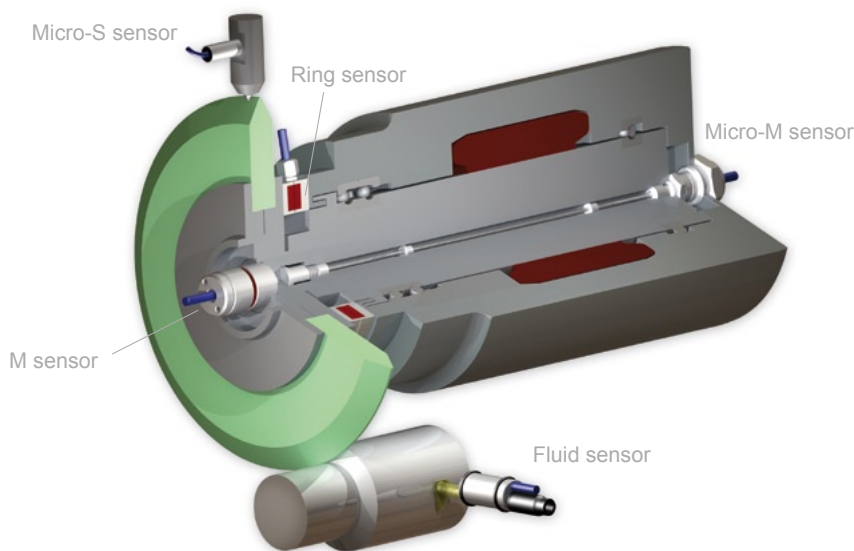

AE signals arising during dressing detected via AE fluid sensor

Rotating sensors

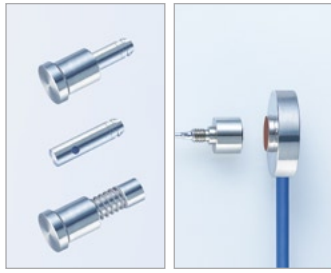
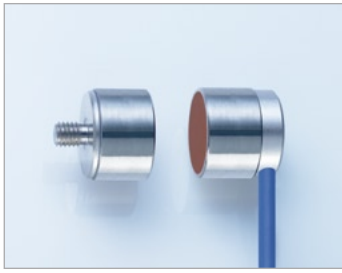

M- and Mini-M sensors:

Applications for example:

Dressing rotating dressing tools:

- Form roller
- Profile roller

Sensor position:

- On the grinding wheel spindle
- On the grinding wheel flange

Additional functions:

- Monitoring of dressing and grinding processes

Customer benefits:

- Simple to assemble
- Measurements on the rotating shaft provide optimal signal-to-noise ratio

Micro-M sensors:

Applications for example:

Dressing rotating dressing tools:

- Form roller
- Profile roller

Sensor position:

- In the wheel spindle
- In the dresser spindle

Additional functions:

- Monitoring of dressing and grinding processes

Customer benefits:

- Proximity to process and large signal recording area provide high signal quality

Ring sensors:

Applications for example:

Dressing rotating dressing tools:

- Form roller
- Profile roller

Sensor position:

- On the chuck
- On the grinding wheel spindle
- On the grinding wheel flange

Additional functions:

- Monitoring of dressing and grinding processes

Customer benefits:

- Direct contact to dressing or grinding tool ensures highest signal quality

High-speed R sensor:

The newly developed high-speed R sensor can detect acoustic emissions in close proximity to the grinding process. In order to better isolate the sensor from sources of interference, e.g. bearings, DITTEL has integrated its AE sensors into the fastening nut of the grinding mandrel. The flow of cooling lubricant through the grinding mandrel has hardly any effect on signal quality. The high-speed R sensor, with an external diameter of 30 mm, can be operated at a maximum rotational speed of 100,000 1/min in combination with DITTEL's evaluation electronics.

Applications for example:

- Internal grinding
- Dressing

Sensor position:

- Integration in the grinding tool coupling nut

Additional functions:

- Monitoring of dressing and grinding processes
- Grinding tool attachment

Customer benefits:

- Easy to assemble
- Direct contact to dressing or grinding tool ensures highest signal quality
- Easy to retrofit

Types	Dimensions [mm]	Thread/ Fastenings	Non-contact signal transm.	Active preamplification possible
S sensor	∅ 21 x 24.5	M 6		
Mini-S sensor	∅ 15 x 23	M 4		
SF-Sensor	45 x 30 x 17	2 x M 5		
Magnet sensor	∅ 40 x 40	magnet		
Mini magnet sensor	∅ 21 x 34.5	magnet		
Fluid sensor	∅ 15 x 30	mounting bracket		
Mini-M sensor	∅ 14 x 9.6	M 4	■	
Mini-M receiver	∅ 20 x 14		■	
M sensor	∅ 21 x 14.2	M 6	■	
M receiver	∅ 21 x 18		■	
Ringsensor	customer specific	customer specific	■	■
Ringreceiver	customer specific	customer specific	■	■
High-speed R sensor	customer specific	customer specific	■	--
Micro-M sensor	customer specific	customer specific	■	■
Micro-M receiver	customer specific	customer specific	■	■

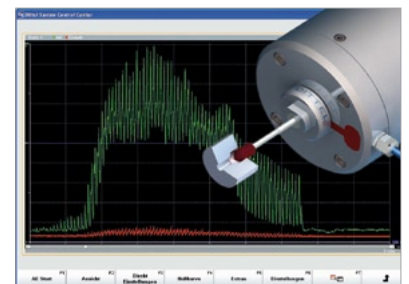

AE signals arising during internal cylindrical grinding detected via high-speed ring sensor

Dittel-System 6000

The DS6000 (Dittel-System 6000) represents a completely new generation of process monitoring and balancing electronics equipment, which acts as an interface between the automation systems and the sensors and/or balancing components, incorporating parameter initialisation, signal processing and signal evaluation.



The DS6000 product family has a modular design, which can be added to and combined with each other. This innovative concept is highly flexible in terms of its ability to meet customer requirements, provides the user with an increased range of features and is very easy to operate.

The DSCC Software (DITTEL System Control Center) was developed for Windows-based automation systems like Siemens SINUMERIK, Heidenhain, Fanuc or Bosch-Rexroth and PCs. The communication between modules and automation systems is made via a static interface, PROFIBUS and RS232 or Ethernet. All modules, their controls and the relevant measurement signals can be displayed on the machine monitor, giving the operator a comprehensive overview of all functions and information. All the data needed for time-saving series commissioning can be saved in an XML file and transferred to other machine controls. This also makes it easy to restore the factory settings.

Our systems can also be operated independently of automation systems using the RC6000 or PC6000 remote controls of DITTEL.

The intelligent use of visualisation provides the user with sufficient information to make full use of the available manufacturing potential and, ultimately, to significantly reduce process costs.

The Dittel-System 6000 includes the electronic modules:

- M6000 Electromechanical balancing control
- P6000 Pre-balancing
- H6000 Hydro-balancing control
- AE6000 basic Process Monitoring basic
- AE6000 AE process control
- DM6000 Process control
- S6000 Acoustic-Emission System

Software:

- Easy to integrate into open Windows-based automation systems
- Easy to integrate software from additional systems
- Freely programmable, Windows-based user surface
- Seamless integration into customer applications via programme interface/ActiveX control elements
- Standard software and operating concept for all DS6000 systems
- Comfortable user guide/prompting
- Intuitive handling
- Integrated online help
- Significant reduction of set-up time
- Complete data protection
- Easily restored to default conditions on servicing
- Optional: Additional equipment functions
- Optional: customer specific software modifications/applications
- Languages: German, English, French, Italian, Spanish, Czech (upgradeable)

Communication interfaces:

- RS232 or Ethernet interface (alternatively: USB with adapter) to connect Automation System
- Profibus (Profibus connection significantly reduces wiring – 9-pole D-SUB)
- Control signal inputs/outputs via static interface and/or via Profibus
- Static interface: 25-pole D-SUB
- All digital inputs/outputs via optocoupler

Standard cables for all DS6000 products:

- PUR jacket: coolant resistant
- Fully shielded
- Suitable for use with drag chains
- Certified according to UL AWM 20963 80°C 30 V E63216 and CSA AWM I/ II A/B 90°C 30V FT1 LL46064

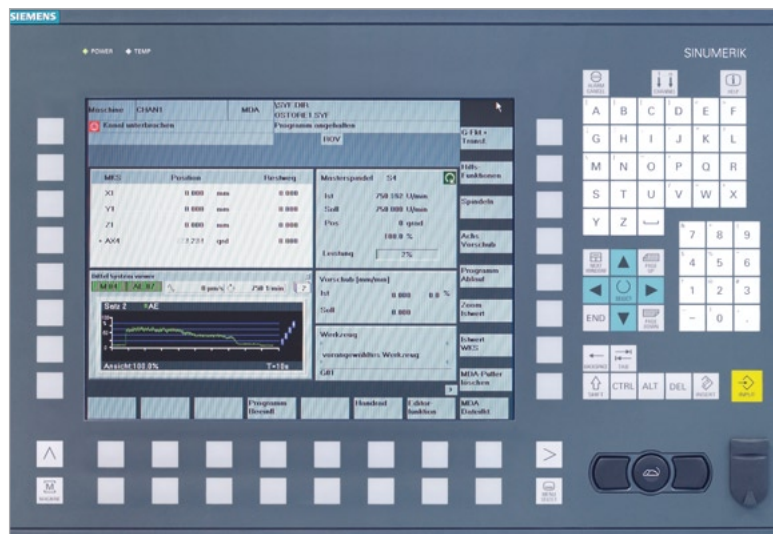

The DSCC Software (DITTEL System Control Center) was developed for Windows-based automation systems like Siemens SINUMERIK, Heidenhain, Fanuc or Bosch-Rexroth and PCs.

M6000

Electromechanical balancing control

The M6000 electromechanical balancing control electronics have been developed especially for use in precision machine tools. The M6000 measures the quantity and position of any grinding wheel imbalance. Compensation is performed during grinding breaks using electromechanically adjusted balancing weights - with high precision, contact free and at operating RPMs.

Basic functions:

- Fully automated grinding wheel balancing
- Profibus and static interface to machine controls
- Compatible with previous M5000
- Improved balancing strategy
- Series set-up of multiple modules with all parameters
- "Open architecture" i.e. updates, software specific to customer and new functions can be integrated flexibly

Additional functions:

- Single plane and two plane field balancing
- Two plane automatic balancing
- Presentation of grinding spindle's frequency spectrum

Customer benefits:

- Optimization of workpiece quality
- Prolonged operating life of individual machine components (spindle, grinding wheel etc.)
- Grinding machine is more cost efficient

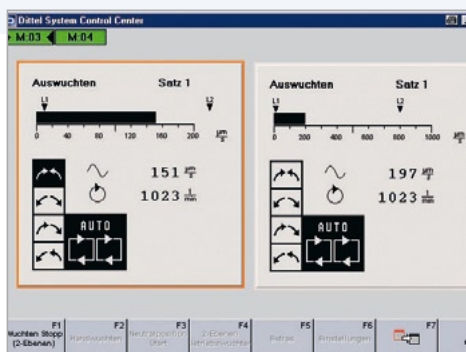

M6000 Two plane automatic balancing

P6000

Pre-balancing

During „pre-balancing“, the unbalance is measured while the machine is running and compensated by shifting correction weights or by adding defined weights to the wheel clamping flange. The spindle is balanced in one plane or two planes, depending on the application.

Spread angle method: unbalance is compensated by shifting two equally heavy weights (sliding blocks) to the calculated positions.

Fixed position method: unbalance is compensated by adding defined weights (e.g. screws) at specific positions.

Basic functions:

- Profibus and static interface to machine monitoring system
- Series start-up of several modules for all parameters
- „Open system architecture“
- Intelligent graphical user prompting
- Continuous unbalance monitoring with 2 limits per measurement channel
- RPM monitoring with 1 limit per proximity switch
- RPM input from rotary encoder

Additional functions:

- Integration into customer applications possible.

Customer benefits:

- System developed specifically for use in precision tool machines
- Size and locations of unbalance are determined while the machine tool is running at operation speed.
- Balanced grinding wheels, tool holders and spindles generate better surface accuracies.

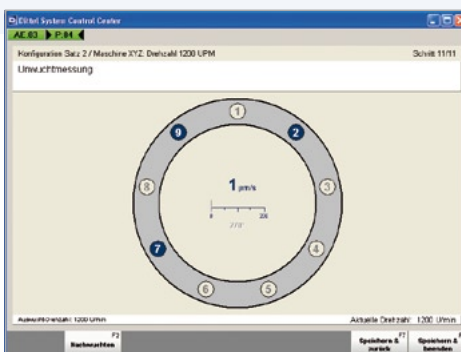

P6000

H6000

Hydro-balancing control

The H6000 hydro-balancing control electronics have been developed especially for use in precision grinding machines not equipped with a balancing system at the centre of the grinding spindle. The H6000 continuously measures the size and position of any grinding wheel imbalance during breaks in the grinding process and calculates the size and position of the compensation weight. Cooling lubricant is then injected into one of the chambers of the balancing container - with high precision, contact free, fully automated and at operating RPMs.

Basic functions:

- Grinding wheel balancing is fully automated: coolant is injected into a three or four chamber balancing container
- Profibus and static interface to machine controls
- Compatible with previous HBA4000
- Improved balancing strategy
- Series set-up of multiple modules with all parameters
- "Open architecture" i.e. updates, software specific to customer and new functions can be integrated flexibly

Additional functions:

- Field balancing
- Presentation of grinding spindle's frequency spectrum

Customer benefits:

- Optimization of workpiece quality
- Prolonged operating life of individual machine components (spindle, grinding wheel etc.)
- Grinding machine is more cost efficient

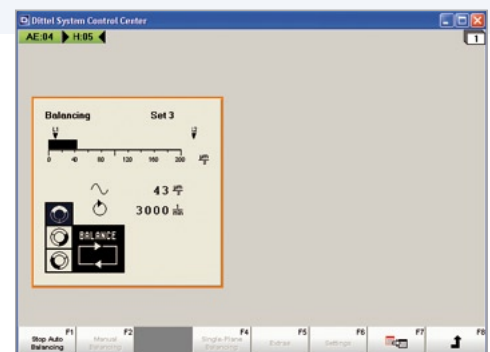

H6000

AE6000

AE process control

Automated grinding or dressing processes must run safely and stably, and produce a consistent level of workpiece quality. Process monitoring on the basis of highly sensitive acoustic emission sensors combined with the AE6000 evaluation unit is the ideal solution to improving process stability. This system can be used to reduce air grinding time, to detect first contact, to detect the first cut during touch dressing, dressing monitoring, grinding process monitoring and wheel damage or collision monitoring.

Basic functions:

- Compatible with previous AE4000/AE4100
- Profibus and static interface to machine controls
- "Passive" and "active" AE sensors and voltage sensors can be connected
- Auto setup function
- Series setup of multiple modules with all parameters
- "Open architecture" i.e. updates, software specific to customer and new functions can be integrated flexibly

Additional functions:

- Envelope function

Customer benefits:

- Optimization of grinding and dressing process, improving workpiece quality and making the grinding machine more cost efficient

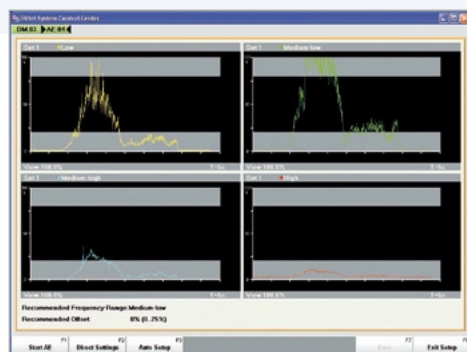

AE6000 Auto setup

DM6000

Process control

The DM6000 process monitoring module enables you to evaluate sensor-based and internal control data.

The increased demands placed on the grinding process over the past few years have led to the introduction of new technologies. In order to make full use of a machine's reserves at increasingly high cutting speeds, one must use the appropriate sensors to detect threshold values during the grinding and dressing processes. Should the measured data exceed the tolerances, corrective action can be taken before the process degenerates without intervention on the part of the machine operator.

Internal control data, e.g. torque, is transferred via Profibus to the module where monitoring takes place. The data set for each monitoring strategy can be flexibly allocated to a signal source. AE/Crash, the voltage input and Profibus inputs are treated equally and can be used for envelope monitoring. When using digital drives, even sensorless process monitoring is possible with the aid of internal control data.

Feedback to the controls is made via Profibus or static interface.

Special features:

- Evaluation of user-defined 4-byte signals via Profibus
- Also available in combination with the SINUMERIK Profibus tool and process monitoring
- Unrestricted allocation of 10 limits to signal sources



DM6000 Evaluation real power

AE6000 Basic

AE - Process Monitoring System

Consistent high quality, automation, increased productivity reduction of downtimes – these are the demands of the machine tool industry for production processes. During grinding or dressing sequences, it is consistent workpiece quality. Even when the cycle is optimized a completely safe and trouble free run cannot be guaranteed, thus the need to monitor the process becomes essential.

The acoustic emission (AE) signal is an ideal and safe criterion for such an evaluation.

The operation of AE6000 basic is very simple and fully automatic, controlled by the machine control.

Basic functions:

- Process monitoring with analog AE-Signal
- Passive and Active Sensors possible
- Signal will be displayed on a 10-element LED bar graph at the unit
- 9 pol. hardware interface connection to machine control
- Digital outputs are optically isolated

Customer benefits:

Fully automatically system for process monitoring as well as touch signal, touch dressing control and reduction of air grinding time.

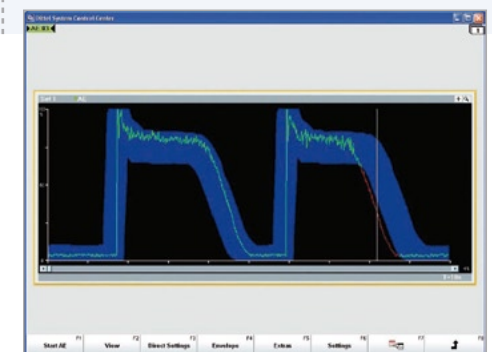

AE6000 Envelope

RC6000

Remote Control

The RC6000 remote control is an accessory for the DS6000 series. This external unit is required for systems without e.g. PC based automation systems, where the DS6000 module can not be operated and visualised via the Windows user interface.

Basic functions:

- RS232 interface to base unit
- Monochrome LCD monitor



PC6000

Remote Control

The PC6000 external control unit is an additional extra for the DS6000 generation of basic modules. The PC6000 is needed if there are no Windows based controls and interfaces through which to control and visualize the DS6000 module.

The PC6000 can visualize several modules at one time, as well as the pre-balancing, spectrum and envelope functions.

Basic functions:

- RS232 interface to basic device
- Color sensor monitor (touch screen)



S6000

Acoustic-Emission System

For the automation of grinding- or dressing sequences it is more and more important to optimize the process and safe workpiece quality. The acoustic emission (AE) signal is an ideal and safe quality of criterion for evaluation.

The AE-Signal of the S6000 will be visualizes over optical LED's over the WINDOWS based machine.

Basic functions:

- Passive and Active Sensors possible
- Signal will be displayed on a LED's on the machine control screen
- Profibus and static interface to machine control.
- Could be visualized via RS232 or Ethernet on the machine control

Customer benefits:

WINDOWS based unit with LED's for shortening the air grinding time, touch dressing control and for the process control.

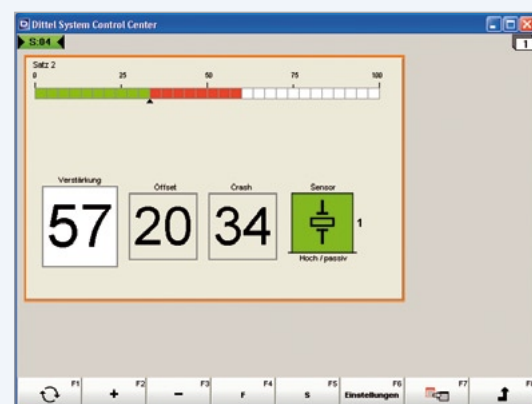

SENSITRON 6

AE evaluation electronics

The Sensitron6 is a new type of AE evaluation electronics that can help to monitor and stabilize complex grinding processes. The high performance grinding process monitoring and control electronics are easy to integrate into the machine controls where they evaluate the signals detected by the highly sensitive AE sensors. The Sensitron6 reliably detects the initial contact between the grinding tool and workpiece, detects spark-up and automatically changes the feed rates in order to reduce air grinding time without loss of quality. An integrated crash monitoring function within the working space is a useful security measure that can minimize the costs arising due to collisions. One can select the sensors and operate the evaluation electronics either manually via push buttons or fully automatically via the machine controls. The AE signal is displayed on a LED bar graph (with 30 graduations).

Basic functions:

- Static interface (digital I/O's) to machine control
- Evaluation of the filtered AE signal
- Crash function
- Up to 2 AE sensors can be connected

Customer benefits:

- Optimization of grinding and dressing process, improving workpiece quality and making the grinding machine more cost efficient



Serie M 5100 M / M 5100 MA

The M5100MA combines the monitoring and control electronics needed for electromechanical balancing and the evaluation of data generated by highly sensitive acoustic emission sensors, in order to optimize grinding and dressing processes. The device is controlled via the menu displayed on an illuminated, monochrome LCD monitor.

Basic functions:

- Fully automatic grinding wheel balancing
- Static interface (digital I/O's) to machine controls
- Field balancing
- Presentation of grinding spindle's frequency spectrum
- Four AE sensors and a voltage sensor can be connected

Additional functions:

- Remote control via RS232 interface with PC software for Windows user interface at machine controls.
- Separate remote control (M5000B)

Customer benefits:

- Prolongs the operating life of individual machine components (spindle, grinding wheel etc.)
- Optimization of grinding and dressing process, improving workpiece quality and making the grinding machine more cost efficient

The 5000 series includes:

- M5000B Remote Control
- M5100M Balancing control
- M5100M-2SP Balancing control for 2 spindles
- M5100MA Balancing- and AE Process control
- M5100MA-2SP Balancing- and AE Process control for 2 spindles
- M5100ME Balancing- and AE Process control (incl. Envelope)



4000 series

The 4000 series is ideal for visualising and monitoring grinding processes on grinding machines where the machine controls are not equipped with their own monitor. The use of acoustic emission systems enables the user to optimize the grinding and dressing process, to reduce air grinding and to monitor for collisions between grinding wheel and workpiece. The entire 4000 series is menu-controlled (in 5 languages) via the displays on an illuminated, monochrome LCD monitor.



The 4000 series includes:

- AE4100-1 1 channel AE evaluation
- AE4100-1E 1 channel AE evaluation incl. envelope
- AE4100-2 2 channel AE evaluation
- AE4100-1P 1 channel AE evaluation incl. field balancing

AE4100-1E

The AE4100-1E electronics evaluate the data provided by highly sensitive acoustic emission sensors. The use of this system helps to optimize grinding and dressing processes and reduce the amount of air grinding. The device is controlled via the menu displayed on an illuminated, monochrome LCD monitor. Dynamic thresholds can be evaluated using the additional envelope monitoring module.

An additional envelope module monitors the process dynamically by taking measurements and evaluating the sensor's output voltage over time. Any value that lies above or below the pre-defined envelope sends an error message to the machine controls. One can save up to 31 envelopes and their related parameters.

Basic functions:

- Static interface (digital I/O's) to machine control
- Evaluation of filtered AE signal
- Crash function
- Four AE sensors and a voltage/current sensor can be connected
- Languages: German, English, French, Italian, Spanish

Additional functions:

- Remote control via RS232 interface with PC software for Windows user interface at machine controls.
Not applicable to envelope function

Customer benefits:

- Optimization of grinding and dressing process, improving workpiece quality and making the grinding machine more cost efficient

Spindle Data Logging Unit

Spindle integrated data logger

High performance spindles are among the most important functional components in machine tooling because of their direct influence on precision, productivity and output. The current trend is towards higher revolutions per minute, which increase the potential productivity. This, however, subjects the spindle to extreme loads.

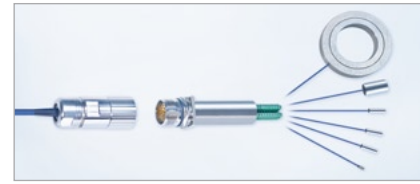

In this situation, our customers need a reliable means of monitoring wear-sensitive components in order to avoid the ultimate cost of repairing damaged spindles. Our spindle data logging unit is integrated into the spindle and reliably records the spindle's history. It consists of an independent monitoring unit capable of monitoring 5 dynamic signals. An alarm signal (recorded with date and time) is activated when predefined limits are exceeded. The data remains stored even when the power is turned off.

Online condition monitoring via a serial interface alerts operators early enough to impending wear-related disturbances for them to plan appropriate maintenance, avoiding spindle damage and the resultant costs of lost production. The records of spindle history enable the spindle manufacturer to determine aspects of spindle behaviour under particular conditions and thus assess warranty claims.

Sensors:

- Digital temperature sensors e.g. for bearings, cooling water
- Analog temperature sensors e.g. in the motor winding
- Acceleration sensors e.g. to record vibrations and bearing acoustics
- Revolution counters
- Tool exchange sensors

Data evaluation:

- Histograms (frequency distributions)
- Trend functions
- Alarm/warning messages
- Maximum values per shift
- Operating hours counter
- Tool exchange

Assembly/Size:

The data logging unit can be mounted onto the back of the spindle or in a separate housing

- Diameter: 21 mm

Supply voltage and power input:

- 15 – 30 V; < 3 W

Spindle Data Logging Unit

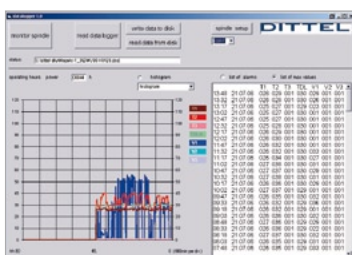
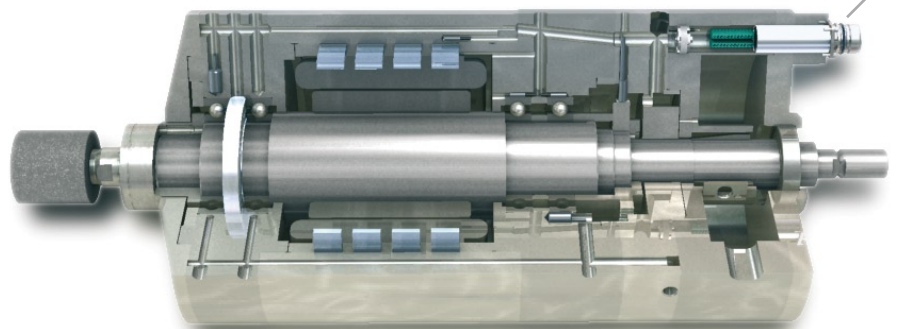

Maximum values over time



Histogram

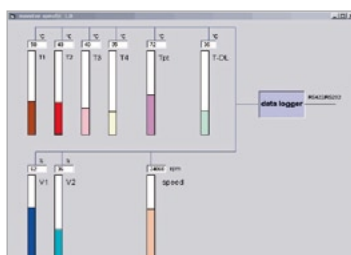

Online mode



Alarms & warnings

Our Agencies worldwide

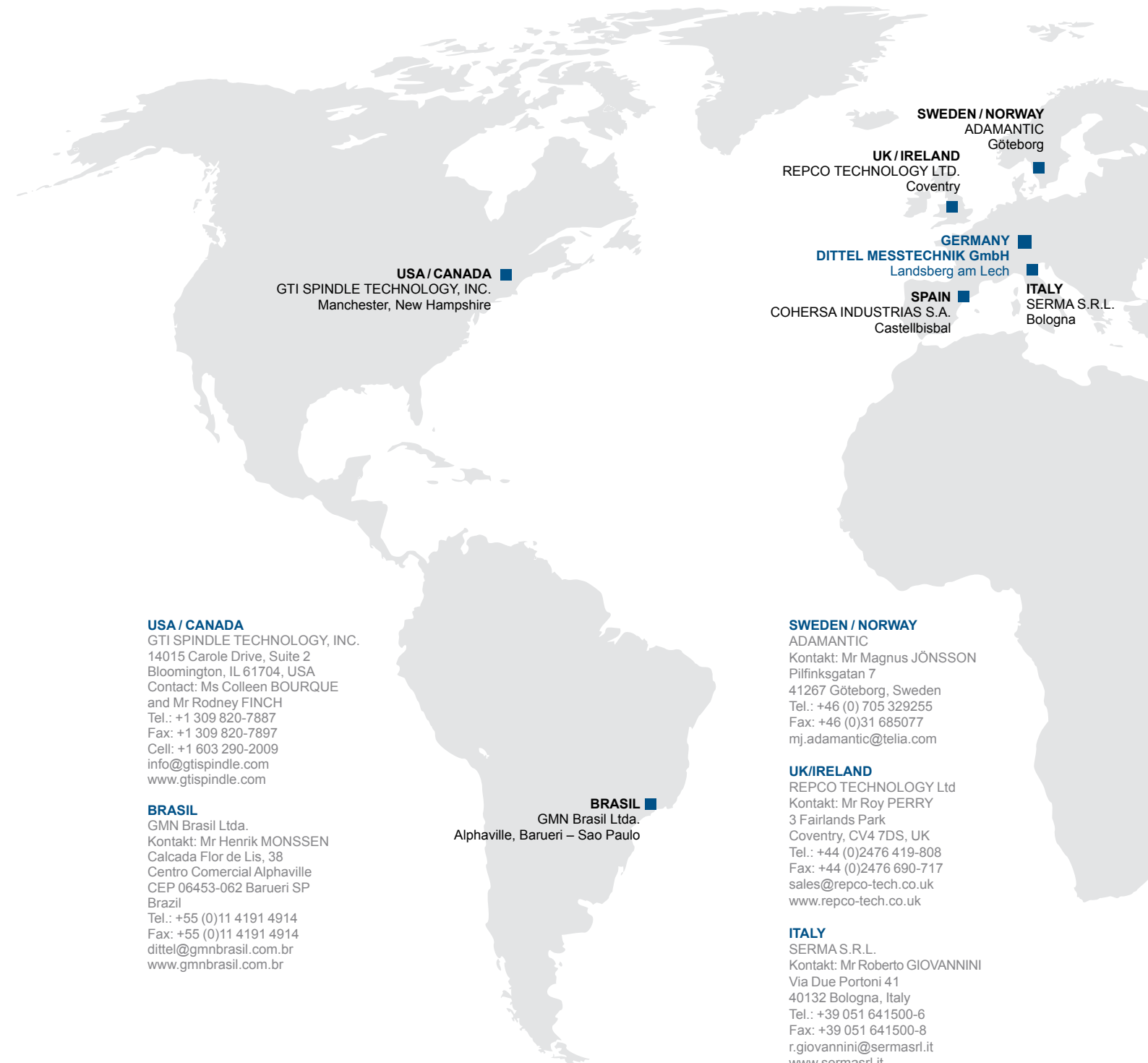

USA / CANADA ■
GTI SPINDLE TECHNOLOGY, INC.
Manchester, New Hampshire

USA / CANADA
GTI SPINDLE TECHNOLOGY, INC.
14015 Carole Drive, Suite 2
Bloomington, IL 61704, USA
Contact: Ms Colleen BOURQUE
and Mr Rodney FINCH
Tel.: +1 309 820-7887
Fax: +1 309 820-7897
Cell: +1 603 290-2009
info@gtispindle.com
www.gtispindle.com

BRASIL ■
GMN Brasil Ltda.
Kontakt: Mr Henrik MONSSEN
Calleada Flor de Lis, 38
Centro Comercial Alphaville
CEP 06453-062 Barueri SP
Brazil
Tel.: +55 (0)11 4191 4914
Fax: +55 (0)11 4191 4914
dittel@gmnbrasil.com.br
www.gmnbrasil.com.br

BRASIL ■
GMN Brasil Ltda.
Alphaville, Barueri – Sao Paulo

SWEDEN / NORWAY
ADAMANTIC
Göteborg ■
UK / IRELAND
REPCO TECHNOLOGY LTD.
Coventry ■

GERMANY ■
DITTEL MESSTECHNIK GmbH
Landsberg am Lech ■
SPAIN ■
COHERSA INDUSTRIAS S.A.
Castellbisbal ■
ITALY
SERMA S.R.L.
Bologna ■

SWEDEN / NORWAY
ADAMANTIC
Kontakt: Mr Magnus JÖNSSON
Pilfinksgatan 7
41267 Göteborg, Sweden
Tel.: +46 (0) 705 329255
Fax: +46 (0)31 685077
mj.adamantic@telia.com

UK / IRELAND
REPCO TECHNOLOGY Ltd
Kontakt: Mr Roy PERRY
3 Fairlands Park
Coventry, CV4 7DS, UK
Tel.: +44 (0)2476 419-808
Fax: +44 (0)2476 690-717
sales@repco-tech.co.uk
www.repco-tech.co.uk

ITALY
SERMA S.R.L.
Kontakt: Mr Roberto GIOVANNINI
Via Due Portoni 41
40132 Bologna, Italy
Tel.: +39 051 641500-6
Fax: +39 051 641500-8
r.giovannini@sermasrl.it
www.sermasrl.it

SPAIN
COHERSA INDUSTRIAS S/A
Kontakt: Mr Luis Carlos
Ramírez BIGORDÁ
Polígono Industrial Comte de Sert
C/ Indústria, 14
08755 Castellbisbal (Barcelona), Spain
Tel.: +34 93 7724298
Fax: +34 93 7724410
lcramirez@coheresa.com
www.coheresa.com

RUSSIA
EUROSHLIF LTD.
Moskau

CHINA
UNIVERSAL HONGKONG
TECHNOLOGY CO., LTD.
Beijing

KOREA
DG Technology
Seoul

JAPAN
FUKUDA CORPORATION
Tokyo

TAIWAN
JOIN STAR TRADING CO., LTD.
Taipei

INDIA
NN COMBINED
ENGINEERING AGENCIES
PVT. LTD.
Secunderabad

RUSSIA
EUROSHLIF Ltd.
Contact: Mrs Nataliya KOVALENKO
and Mr. Denis BELUSOV
ul. Kotlykovskaya 7/8
115201 Moskau
Russland
Tel.: / Fax: Moskau: +7 (8) 495 983 11 90
Tel.: / Fax: Samara: +7 (8) 925 585 66 10
euroshlif@mail.ru
www.euroshlif.ru

INDIA
NN COMBINED ENGINEERING
AGENCIES PVT. LTD.
Kontakt: Mr Nikhil NAYAK
125 M.G. Road
Dr. Ranji Block, First Floor
Secunderabad 500 003 AP, India
Tel.: +91 (0)40 2784-4279, 2789-8579
Fax: +91 (0)40 2784-1652
mail@nncea.com
www.nncea.com

CHINA
UNIVERSAL HONGKONG
TECHNOLOGY. LTD.
Kontakt: Mrs Galen GAI
B615-619, Capital Group Plaza
No.6 Chaoyangmen Beidajie
Dongcheng District
Beijing 100027, P.R.China
Tel.: +86 (0)10 85283377
Fax: +86 (0)10 85282755
galen@universalkhco.com.cn
www.universalkhco.com.cn

KOREA
DG TECHNOLOGY Co., LTD
Kontakt: Mr Dae Gen KIM
#1306, ACE HI-END TOWER 8
345-4 Gasan-Dong, Geumcheon-Gu
Seoul 153-802, Korea
Tel: +82 (0) 2 2611 1048
Fax: +82 (0) 2 2611 1059
dgkim@dgte.kr
www.dgte.kr

JAPAN
FUKUDA CORPORATION
Kontakt: Mr Tatsuo KOISO
11-2, Akashicho, Chuo-ku
Tokyo 104-0044, Japan
Tel.: +81 (0)3 5565-6826
Fax: +81 (0)3 5565-6839
koiso@fukudaco.co.jp
www.fukudaco.co.jp

TAIWAN
JOIN STAR TRADING CO., LTD.
Kontakt: Mr Ali SUNG
No. 1 Lane 550, Chung Chen Road
Hsin Tien City, Taipei county, Taiwan
R.O.C.
Tel.: +886 (0)2 8867-6366
Fax: +886 (0)2 8867-3236
joinstar@ms13.hinet.net
www.join-star.com.tw

DITTEL



Dittel Messtechnik GmbH
Erpfinger Straße 36
86899 Landsberg am Lech
Germany

Tel.: +49 (0)81 91 3351-0
Fax: +49 (0)81 91 3351-49
info@dittel.com
www.dittel.com